



# OWNER'S GUIDE &

# INSTALLATION INSTRUCTIONS

## Thru-Hull: Retractable with Valve & Temperature Sensor Tilted Element™ Transducer Tilt Angles: 0°, 12°, 20°

Model: **DT800**

Patent <http://www.airmar.com/patent.html>

Smart™ Sensor

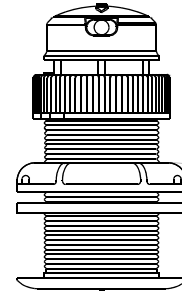

plastic  
low profile  
P617V housing

### Follow the precautions below for optimal product performance and to reduce the risk of property damage, personal injury, and/or death.

**WARNING:** Always wear safety glasses, a dust mask, and ear protection when installing.

**WARNING: The valve is not a watertight seal!** Always install the insert or blanking plug. Be sure it is fully inserted into the housing and the cap nut is screwed on completely for a watertight seal.

**WARNING:** All the O-rings must be intact and well lubricated to make a watertight seal. Do not dry fit the insert in the housing. Attempting to install the insert without lubricating all O-rings will damage them, possibly preventing full insertion and a watertight seal.

**WARNING:** The **YELLOW** O-ring must be in place near the top of the insert to make a watertight seal.

**WARNING:** To retrofit the insert in a housing *without* a valve, the insert must have a **BLACK** O-ring near the top to make a watertight seal.

**WARNING:** Always attach the safety wire to prevent the insert or blanking plug from backing out in the unlikely event that the cap nut fails or is screwed on incorrectly.

**WARNING:** Immediately check for leaks when the boat is placed in the water. Do not leave the boat unchecked for more than three hours. Even a small leak may allow considerable water to accumulate.

**WARNING: Stainless steel housing in a metal hull**—Be sure the washer contacts the hull. Do not tighten the hull nut with the washer against the isolation bushing, as the housing will not be firmly installed.

**CAUTION:** Never pull, carry, or hold the sensor by its cable; this may sever internal connections.

**CAUTION:** The arrow on the top of the insert must point toward the keel/centerline of the boat. This will align the angle of the element inside the transducer with the deadrise angle of your hull.

**CAUTION: Plastic housing**—Never use a fairing with a plastic housing; the protruding sensor would be vulnerable to damage from impact.

**CAUTION: Metal housing**—Never install a metal housing in a vessel with a positive ground system.

**CAUTION: Stainless steel housing in a metal hull**—A stainless steel housing must be isolated from a metal hull to prevent electrolytic corrosion. Use the isolation bushing supplied.

**CAUTION:** Never use solvents. Cleaner, fuel, sealant, paint, and other products may contain solvents that can damage plastic parts, especially the transducer's face.

**CAUTION:** Never power sand or pressure wash the sensor. It may weaken the structure or damage the internal components.

Record the information found on the cable tag for future reference.

Part No. \_\_\_\_\_ Date \_\_\_\_\_ Frequency \_\_\_\_\_ kHz

### Important

Read the instructions completely before proceeding with the installation. These instructions supersede any other instructions in your instrument manual if they differ.

### Applications

- **Plastic** housing recommended for fiberglass or metal hull only. *Never install a plastic housing in a wood hull since swelling of the wood can fracture the plastic.*
- **Bronze** housing recommended for fiberglass or wood hull. *Never install a bronze housing in an metal hull because electrolytic corrosion will occur.*
- **Stainless steel** housing compatible with all hull materials. Recommended for aluminum hulls to prevent electrolytic corrosion *provided the stainless steel housing is isolated from the metal hull.*

### Match Tilt Angle of Transducer to Deadrise Angle

Be sure your transducer model matches the deadrise angle of your hull at the mounting location. See the top of the transducer insert for the tilt angle (Figure 1). Measure the deadrise angle of your hull at the selected mounting location (Figure 2).

- 0° model for deadrise angles from 0° to 7°
- 12° model for deadrise angles from 8° to 15°
- 20° model for deadrise angles from 16° to 24°

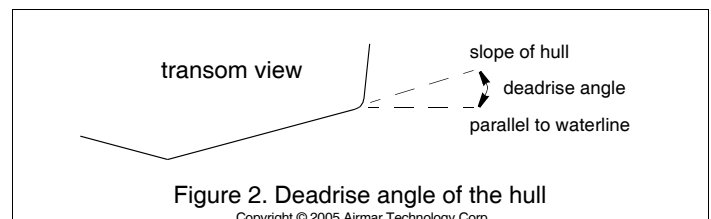
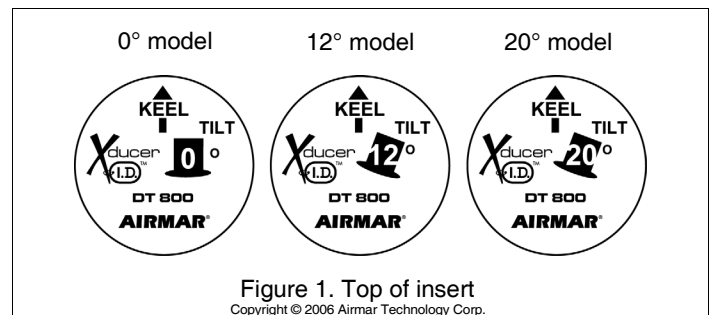

01/20/22

17-431-01-rev.9

D-17-431-01-rev.9

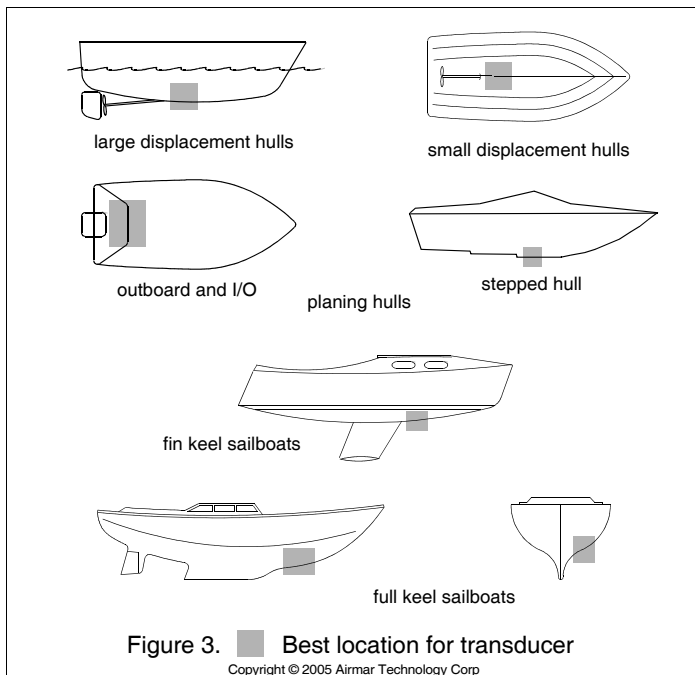

## Tools & Materials

Safety glasses

Dust mask

Ear protection

Angle finder *or* smart device

Water-based anti-fouling coating (**mandatory in salt water**)

Electric drill [Ø 10mm (3/8") or larger chuck capacity]

Drill bit: Ø 3mm *or* 1/8"

Hole saw: Ø 51 mm *or* 2" (plastic or metal housing in non-metal hull)

Ø 57 mm *or* 2-1/4" (stainless steel housing in a metal hull)

Sandpaper

Mild household detergent *or* weak solvent (such as alcohol)

File (installation in a metal hull)

Marine sealant (suitable for below waterline)

Slip-joint pliers (installing a metal housing)

Grommet(s) (some installations)

Cable ties

Installation in a cored fiberglass hull (page 4):

Hole saw for hull interior: Ø 60mm *or* 2-3/8"

Fiberglass cloth and resin

*or* Cylinder, wax, tape, and casting epoxy

## Mounting Location

**CAUTION:** Do not mount the sensor in line with or near water intake or discharge openings or behind strakes, fittings, or hull irregularities that may disturb the water flow.

- The water flowing under the hull must be smooth with a minimum of bubbles and turbulence, especially at high speeds.
- The sensor must be continuously immersed in water at all speeds.
- The transducer beam must be unobstructed by the keel or propeller shaft(s).
- Choose a location away from interference caused by power and radiation sources such as: the propeller(s) and shaft(s), other machinery, other echosounders, and other cables. The lower the noise level, the higher the echosounder gain setting that can be used.
- Choose an accessible spot inside the vessel with adequate space for the height of the housing, tightening the nuts, and removing the insert. Allow a minimum of 280mm (11").

## Boat Types (Figure 3)

- **Displacement hull powerboats**—Locate the sensor amidships near the centerline. The side of the hull where the propeller blades are moving downward is preferred.
- **Planing hull powerboats**—Mount the sensor well aft, on or near the centerline, and *well inboard of the first set of lifting strakes* to ensure that the transducer will be in contact with the water at high speeds. The side of the hull where the propeller blades are moving downward is preferred.
- **Outboard and I/O**—Mount just forward of the engine(s).
- **Inboard**—Mount well ahead of the propeller(s) and shaft(s).
- **Stepped hull**—Mount just ahead of the first step.
- **Boat capable of speeds above 25kn (29MPH)**—Review the installation location and operating results of similar boats before proceeding.
- **Fin keel sailboats**—Mount on or near the centerline and forward of the fin keel 300 to 600mm (1 to 2').
- **Full keel sailboats**—Locate amidships and away from the keel.

## Anti-fouling Coating

Surfaces exposed to saltwater must be covered with an anti-fouling coating. *Use only water-based anti-fouling coating made for transducers.* Never use ketone-based paint, since ketones can attack many plastics possibly damaging the sensor. It is easier to brush on anti-fouling coating before installation, but allow sufficient drying time. Re-coat every 6 months or at the beginning of each boating season. Coat the following surfaces (Figure 4):

- Outside wall of the insert below the lower O-ring
- Exposed end of the insert
- Exterior flange of the housing
- Bore of the housing up 30mm (1-1/4")
- Blanking plug below the lower O-ring including the exposed end.

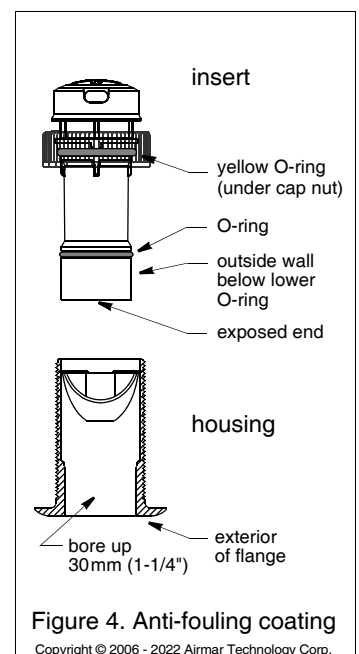

## Installation

### Hole Drilling

**Cored fiberglass hull**—Follow separate instructions on page 4.

1. Drill a Ø 3mm or 1/8" pilot hole from inside the hull. If there is a rib, strut or other hull irregularity near the selected mounting location, drill from the outside.
  2. Using the appropriate size hole saw, cut a hole *perpendicular* to the hull from outside the boat.
  3. Sand and clean the area around the hole, inside and outside, to ensure that the sealant will adhere properly to the hull. If there is any petroleum residue inside the hull, remove it with either mild household detergent or a weak solvent (alcohol) before sanding.
- Metal hull**—Remove all burrs with a file and sandpaper.

### Bedding

**CAUTION:** Be sure the surfaces to be bedded are clean and dry.

Apply a 2mm (1/16") thick layer of marine sealant around the flange of the housing that will contact the hull and up the sidewall of the housing (Figure 5). *The sealant must extend 6mm (1/4") higher than the combined thickness of the hull, the washer, and the hull nut.* This will ensure there is sealant in the threads to seal the hull and to hold the hull nut securely in place.

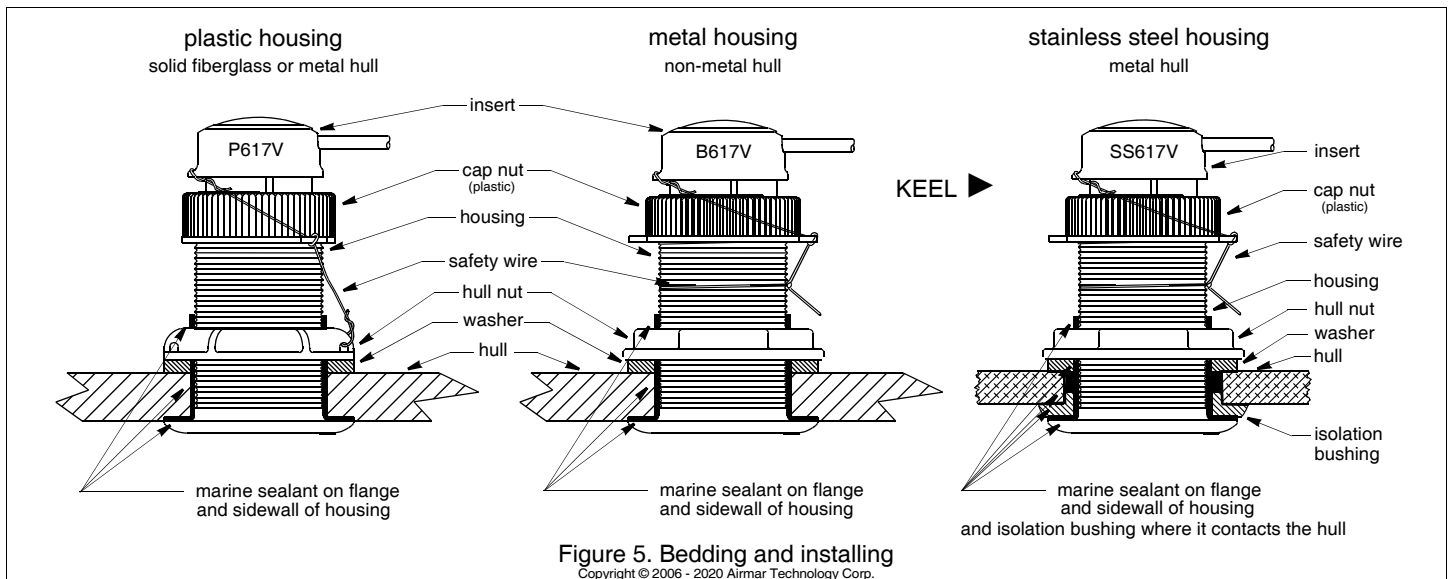

Figure 5. Bedding and installing  
Copyright © 2006 - 2020 Airmar Technology Corp.

**Stainless steel housing in a metal hull**—A stainless steel housing must be isolated from a metal hull to prevent electrolytic corrosion. Slide the isolation bushing onto the housing. Apply *additional* sealant to the surfaces of the isolation bushing that will contact the hull, filling any cavities in and around the bushing.

### Installing

**NOTE:** *Disregard any arrow on the housing; it is not used.*

1. From outside the hull, push the housing into the mounting hole using a twisting motion to squeeze out excess sealant (Figure 5).
2. From inside the hull, slide the washer onto the housing.

**Stainless steel housing in a metal hull**—Be sure the washer contacts the hull. *Do not tighten the hull nut with the washer against the isolation bushing, as the housing will not be firmly installed.* If necessary, sand the isolation bushing until the washer rests against the hull.

3. Screw the hull nut in place.

**Plastic housing**—Do not clamp tightly possibly causing the housing to fracture.

**Plastic hull nut**—**Hand-tighten** only. Do not over tighten.

**Metal hull nut**—Tighten with slip-joint pliers.

**Cored fiberglass hull**—Do not over tighten, crushing the hull.

**Wood hull**—Allow the wood to swell before tightening the hull nut.

4. Remove any excess marine sealant on the outside of the hull to ensure smooth water flow under the sensor.
5. *All the O-rings must be intact and well lubricated to make a watertight seal.* After the marine sealant cures, inspect the O-rings on the insert (replace if necessary) and lubricate them with the silicone lubricant supplied (Figure 7). Be sure the **YELLOW** O-ring is in place near the top. Also lubricate the bore of the housing above the valve.
6. The insert must be fully inserted into the housing and the cap nut screwed on completely to make a watertight seal (Figure 5). **Slide the insert into the housing with the arrow on the top pointing toward the KEEL/centerline of the boat** (Figure 1).
7. Screw the cap nut several turns until the threads are engaged (Figure 5). Being sure the arrow on the top of the insert and the cable exit are pointing toward the keel/centerline, continue to tighten the cap nut completely. Be careful not to rotate the housing and disturb the sealant. **Hand tighten** only. Do not over tighten.
8. Always attach the safety wire to prevent the insert from backing out in the unlikely event that the cap nut fails or is screwed on incorrectly.

**Plastic housing**—Attach the safety wire to one eye in the hull nut. Keeping the wire taut throughout, lead the wire in a counterclockwise direction and thread it through one eye in the

cap nut. Thread the wire through the eye a second time. Then lead the wire through the eye in the insert. Twist the wire securely to itself.

**Metal housing**—Wrap one end of the safety wire tightly around the housing and twist it together with the long end. Keeping the wire taut throughout, lead the wire straight up and through one eye in the cap nut. Thread the wire through the eye a second time. Then lead the wire counterclockwise and through the eye in the insert. Twist the wire securely to itself.

### Installing in Housing *WITHOUT* Valve

To create a watertight seal in a housing that does NOT have a valve, the insert must have a **BLACK** O-ring near the top. Use Replacement O-ring Kit 20-519-01 and follow the instructions supplied.

### Cable Routing & Connecting

**CAUTION:** If your sensor came with a connector, do not remove it to ease cable routing. If the cable must be cut and spliced, use Airmar's splash-proof Junction Box No. 33-035 and follow the instructions provided. Removing the waterproof connector or cutting the cable, except when using a watertight junction box, will void the sensor's warranty.

1. Route the cable to the instrument being careful not to tear the cable jacket when passing it through the bulkhead(s) and other parts of the boat. Use grommets to prevent chaffing. To reduce electrical interference, separate the sensor cable from other electrical wiring and the engine. Coil any excess cable and secure it in place with cable ties to prevent damage.
2. Refer to the instrument owner's manual to connect the sensor to the instrument.

### Checking for Leaks

When the boat is placed in the water, **immediately** check around the sensor for leaks. Note that very small leaks may not be readily observed. Do not leave the boat in the water for more than 3 hours before checking it again. If there is a small leak, there may be considerable bilge water accumulation after 24 hours. If a leak is observed, repeat "Bedding" and "Installing" **immediately** (page 2).

## Installation in a Cored Fiberglass Hull

The core (wood or foam) must be cut and sealed carefully. The core must be protected from water seepage, and the hull must be reinforced to prevent it from crushing under the hull nut allowing the housing to become loose.

**CAUTION:** Completely seal the hull to prevent water seepage into the core.

1. Drill a  $\varnothing$  3 mm or 1/8" pilot hole from inside the hull. If there is a rib, strut, or other hull irregularity near the selected mounting location, drill from the outside. (If the hole is drilled in the wrong location, drill a second hole in a better location. Apply masking tape to the outside of the hull over the incorrect hole and fill it with epoxy.)
2. Using a  $\varnothing$  51 mm or 2" hole saw, cut the hole from outside the hull through the *outer* skin only (Figure 6).
3. From inside the hull using a  $\varnothing$  60 mm or 2-3/8" hole saw, cut through the *inner* skin and most of the core. The core material can be very soft. Apply only light pressure to the hole saw after cutting through the inner skin to avoid accidentally cutting the *outer* skin.
4. Remove the plug of core material so the *inside* of the outer skin and the inner core of the hull are fully exposed. Sand and clean the inner skin, core, and the outer skin around the hole.
5. If you are skilled with fiberglass, saturate a layer of fiberglass cloth with a suitable resin and lay it inside the hole to seal and strengthen the core. Add layers until the hole is the correct diameter. Alternatively, a hollow or solid cylinder of the correct diameter can be coated with wax and taped in place. Fill the gap between the cylinder and hull with casting epoxy. After the epoxy has set, remove the cylinder.
6. Sand and clean the area around the hole, inside and outside, to ensure that the marine sealant will adhere properly to the hull. If there is any petroleum residue inside the hull, remove it with either mild household detergent or a weak solvent (alcohol) before sanding.
7. Proceed with "Bedding" (page 2).

## Operation & Maintenance

### How the Valve Works

**THE VALVE IS NOT A WATERTIGHT SEAL!** The sensor incorporates a self-closing valve which minimizes the flow of water into the boat when the insert is removed. The curved flap valve is activated by both a spring and water pressure. Water pushes the flap valve upward to block the opening, so there is no gush of water into the boat. Always install the insert or the blanking plug secured with the cap nut and safety wire for a watertight seal.

### Using the Blanking Plug

To protect the insert, use the blanking plug:

- When the boat will be kept in salt water for more than a week.
- When the boat will be removed from the water.
- When aquatic growth buildup on the insert is suspected due to inaccurate readings from the instrument.

1. *All the O-rings must be intact and well lubricated to make a watertight seal.* On the blanking plug, inspect the O-rings (replace if necessary) and lubricate them with the silicone lubricant supplied or petroleum jelly (Figure 7).
2. Remove the insert from the housing by removing the safety wire and unscrewing the cap nut (Figure 5). This will raise the insert. Remove the insert with a slow pulling motion. Replace it by sliding the blanking plug into the housing.

**NOTE:** In the very unlikely event that the valve breaks, replace the housing the next time the boat is hauled.

3. With the blanking plug fully inserted, screw the cap nut several turns until the threads are engaged. Continue to tighten the cap nut completely. **Hand tighten** only. Do not over tighten.

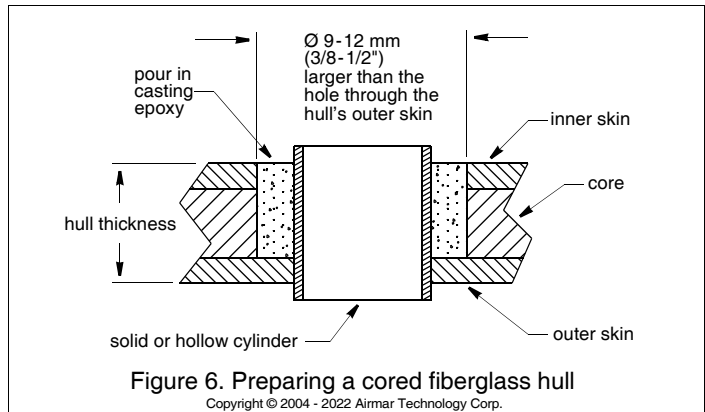

Figure 6. Preparing a cored fiberglass hull

Copyright © 2004 - 2022 Airmar Technology Corp.

**NOTE:** The blanking plug must be fully inserted in the housing and the cap nut screwed on completely for a watertight seal.

4. Reattach the safety wire to prevent the blanking plug from backing out in the unlikely event that the cap nut fails or is screwed on incorrectly.

### Winterizing

After the boat has been hauled for winter storage, remove the blanking plug to let the water drain away before reinserting it. This will prevent any water from freezing around the blanking plug, possibly cracking the plastic.

### Cleaning & Replacing O-rings

Aquatic growth can accumulate rapidly on the sensor's face reducing performance within weeks. Clean the insert with a Scotch-Brite® scour pad and mild household detergent, being careful to avoid making scratches. If fouling is severe, lightly wet sand it with fine grade wet/dry paper.

*All the O-rings must be intact and well lubricated to make a watertight seal.* Install the O-rings on the insert and blanking plug as shown (Figure 7).

### Replacement Sensor & Parts

The information needed to order a replacement Airmar sensor is printed on the cable tag. Do not remove this tag. When ordering, specify the part number, date, and frequency in kHz. For convenient reference, record this information on the top of page one.

Lost, broken, or worn parts should be replaced immediately. If you have purchased a plastic housing and have a wood hull or desire greater strength, purchase an Airmar metal housing. Obtain parts from your instrument manufacturer or marine dealer.

Gemeco

USA

Tel: 803-693-0777

Email: sales@gemeco.com

Airmar EMEA

Europe, Middle East, Africa

Tel: +33.(0)2.23.52.06.48

Email: sales@airmar-emea.com

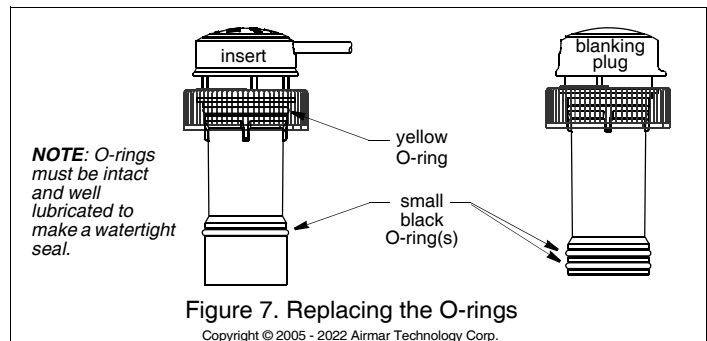

Figure 7. Replacing the O-rings

Copyright © 2005 - 2022 Airmar Technology Corp.