

SAILOR Fleet One

User & installation manual



Document number: 98-141368-B

Release date: 7 April 2015

Disclaimer

Any responsibility or liability for loss or damage in connection with the use of this product and the accompanying documentation is disclaimed by Thrane & Thrane A/S. The information in this manual is provided for information purposes only, is subject to change without notice and may contain errors or inaccuracies. Manuals issued by Thrane & Thrane A/S are periodically revised and updated. Anyone relying on this information should acquire the most current version e.g. from www.cobham.com/communications-and-connectivity/satcom, **Service and support**, or from the distributor. Thrane & Thrane A/S is not responsible for the content or accuracy of any translations or reproductions, in whole or in part, of this manual from any other source. In the event of any discrepancies, the English version shall be the governing text.

Thrane & Thrane A/S is trading as Cobham SATCOM.

Copyright © 2015 Thrane & Thrane A/S. All rights reserved.

Trademark acknowledgements:

- **SAILOR** is a registered trademark of Thrane & Thrane A/S in the European Union, the United States and other countries.
- **Windows** is a registered trademark of Microsoft Corporation in the United States and other countries.
- **Inmarsat** is a registered trademark of International Maritime Satellite Organisation (IMSO) and is licensed by IMSO to Inmarsat Limited and Inmarsat Ventures plc.
- Inmarsat's product names are trademarks or registered trademarks of Inmarsat.
- Other product and company names mentioned in this manual may be trademarks or trade names of their respective owners.

Company web site
www.cobham.com/satcom

Safety summary

The following general safety precautions must be observed during all phases of operation, service and repair of this equipment. Failure to comply with these precautions or with specific warnings elsewhere in this manual violates safety standards of design, manufacture and intended use of the equipment. Thrane & Thrane A/S assumes no liability for the customer's failure to comply with these requirements.

Observe marked areas

Under extreme heat conditions do not touch areas of the terminal or antenna that are marked with this symbol, as it may result in injury.



Microwave radiation hazards

During transmission the antenna in this system radiates Microwave Power. This radiation may be hazardous to humans close to the antenna. During transmission, make sure that nobody gets closer than the recommended minimum safety distance.

On the SAILOR Fleet One, the minimum safety distance to the antenna panel on the focal line is 0.6 m, based on a radiation level of 10 W/m². The radiation level is 100 W/m² at a distance of 0.2 m from the antenna panel. Refer to the drawing below.



Pour une antenne SAILOR Fleet One, la distance de sécurité minimale avec le panneau de l'antenne sur l'axe focal est de 0.6 m, sur la base d'un niveau de radiation émis de 10 W/m². L'appareil génère un niveau de radiation de 100 W/m² à une distance de 0.2 m de l'avant du panneau de l'antenne. Veuillez consulter le schéma au-dessous.

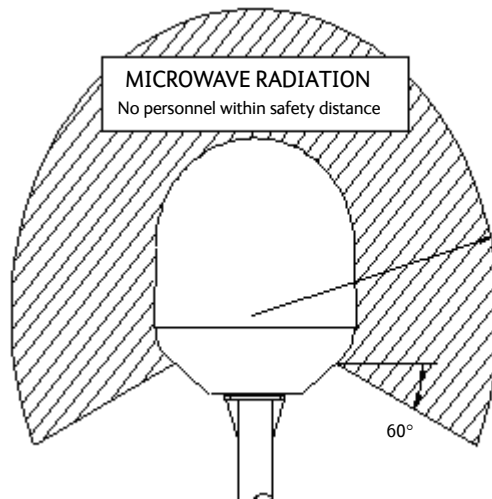

Safety distance:

0.6 m, 10 W/m²
0.2 m, 100 W/m²

Distance to other equipment

Do not move the antenna closer to radars than the min. safe distance specified in the installation manual - it may cause damage to the antenna.

Compass Safe Distance:

SAILOR Fleet One terminal: min. 0.3 m.

SAILOR Fleet One antenna: min. 1.2 m

Service

User access to the interior of the system units is prohibited. Only a technician authorized by Cobham SATCOM may perform service - failure to comply with this rule will void the warranty.

Do not service or adjust alone

Do not attempt internal service or adjustments unless another person, capable of rendering first aid resuscitation, is present.

Grounding, cables and connections

To minimize shock hazard, the equipment chassis and cabinet must be connected to an electrical ground. The terminal must be grounded to the ship. For further grounding information refer to the Installation manual.

Do not extend the cables beyond the lengths specified for the equipment. The cable between the terminal and antenna can be extended if it complies with the specified data concerning cable losses etc.

All cables for the SAILOR Fleet One system are shielded and should not be affected by magnetic fields. However, try to avoid running cables parallel to AC wiring as it might cause malfunction of the equipment.

Power supply

The voltage range is 10.5 - 32 V DC; 11.5 A - 4 A. It is recommended that the voltage is provided by the 24 V DC bus on the ship. Be aware of high start-up peak current: 20 A@24 V, 5 ms.

If a 24 V DC power bus is not available, an external 115/230 VAC to 24 V DC power supply can be used.

Do not operate in an explosive atmosphere

Do not operate the equipment in the presence of flammable gases or fumes. Operation of any electrical equipment in such an environment constitutes a definite safety hazard.

Keep away from live circuits

Operating personnel must not remove equipment covers. Do not replace components with the power cable connected. Under certain conditions, dangerous voltages may exist even with the power cable removed. To avoid injuries, always disconnect power and discharge circuits before touching them.

Failure to comply with the rules above will void the warranty!

Related documents

The below list shows the documents related to this manual and to the SAILOR Fleet One system.

Title and description	Document number
SAILOR Fleet One, Installation guide A short guide to installing the SAILOR Fleet One system	98-141370
SAILOR Fleet One, Quick guide A short guide to the most important functions of the SAILOR Fleet One system	98-141369
IP Handset, User manual Explains the features and functions of the IP Handset. The IP Handset works as a standard IP handset, but also serves as a user interface for the SAILOR Fleet One system.	98-126059

Typography

In this manual, typography is used as indicated below:

Bold is used for the following purposes:

- To emphasize words.
Example: “Do **not** touch the antenna”.
- To indicate what the user should select in the user interface.
Example: “Select **SETTINGS > LAN**”.

Italic is used to emphasize the paragraph title in cross-references.

Example: “For further information, see *Connecting Cables* on page...”.

Table of contents

Chapter 1 Introduction

Your SAILOR Fleet One	1
Features and interfaces	2
Main units	3
Tools for setup and use	4
Available services	4

Chapter 2 Installation

Unpack your SAILOR Fleet One	6
Mounting considerations for the antenna	7
Antenna mast design	11
Install the antenna	13
Mounting considerations for the terminal	16
Install the terminal	17
Connect cables	21
Power cable selection	34

Chapter 3 Get started

Start up the SAILOR Fleet One	37
Connect a smartphone	39
Connect an IP handset	41
Connect an analog phone	42
Connect a computer	42
Make a call	43
Connect to the Internet	44

Chapter 4 Operation

Phone calls	45
Data connection	49
The built-in web interface	51
Dashboard	54

Phone book	57
Call log	59
SMS messages	60
SIM PIN	63

Chapter 5 Configuration

Set up the data connection	67
Set up the interfaces	68
Select a preferred satellite	73
Set coverage restrictions (Geo-fencing)	74
Log on as administrator	75
Save or load a configuration	78
Call charges	79
Log handling	80
Data limits	80
Configure the SIM PIN	81
Set up user permissions	83
Restricted dialling	84
External data connections	86
Track the SAILOR Fleet One	88
Antenna RF noise filter	90
Positioning system	91

Chapter 6 Maintenance and troubleshooting

Get support	92
Update software	93
Part numbers	95
Troubleshooting guide	96
Status signalling	99
Generate a diagnostic report	100
Event messages	101
Extended status	108

Antenna properties 108

Self test 109

Reset button 110

List of reserved subnets 112

App. A Technical specifications

 SAILOR Fleet One antenna 113

 SAILOR Fleet One terminal 117

Glossary 121

Index 124

Introduction

Your SAILOR Fleet One

Congratulations on the purchase of your SAILOR Fleet One System!

SAILOR Fleet One is a maritime broadband system, providing simultaneous high-speed data and voice communication via satellite, using Inmarsat BGAN (Broadband Global Area Network). Used with a phone or computer the SAILOR Fleet One gives you access to:

- Internet browsing
- E-mail
- Phone services
- File transfers
- VPN (Virtual Private Network) access to corporate servers



This chapter has the following sections:

- *Features and interfaces*
- *Main units*
- *Tools for setup and use*
- *Available services*

Features and interfaces

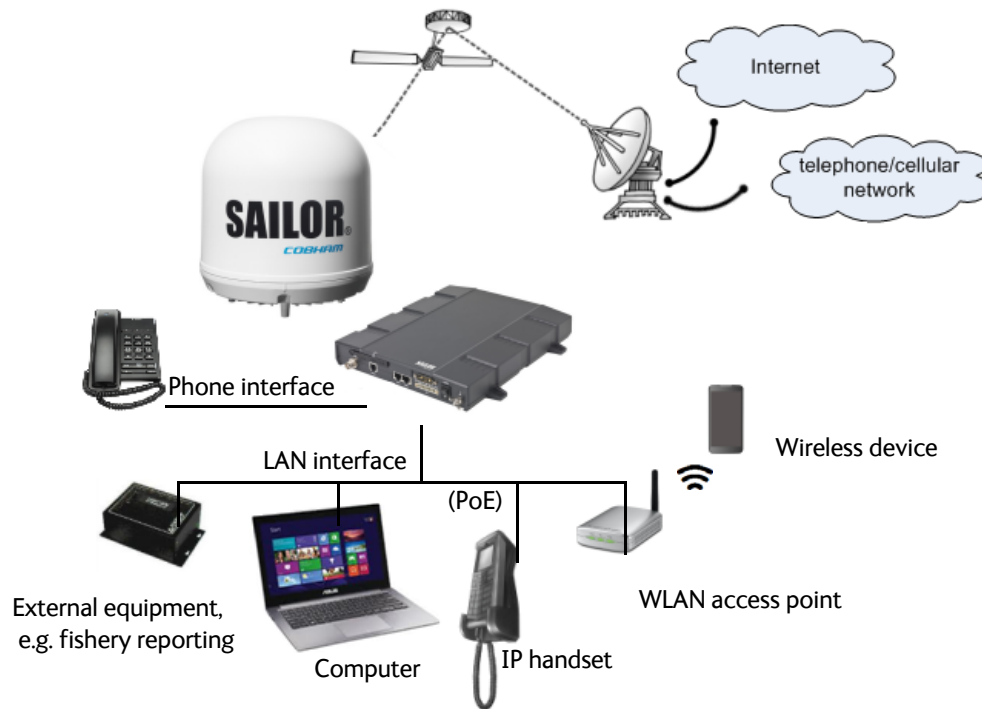

The SAILOR Fleet One system offers the following features and interfaces:

- Simultaneous voice and data communication over BGAN
- Full duplex, single or multi-user, up to: 100 kbps
- Standard Voice (4 kbps)
- 2 LAN (Local Area Network) ports with PoE (Power over Ethernet) for connecting computers, e-hubs, IP handsets, WLAN access point etc.
- 1 Standard Phone port
- 1 multi-purpose I/O connector with 5 configurable inputs/outputs
- 1 SIM slot for your Fleet One SIM card
- Support for GPS, GLONASS and BeiDou-1 positioning systems
- Built-in DHCP/NAT router
- Built-in web interface for managing phone book, messages and calls, and configuration
- Input power: 10.5 - 32 V DC (11.5 A - 4 A)
- CE certified
- ATC resilient
- Supports Inmarsat's extended L-band services, Inmarsat-XL

Main units

Units included

The **SAILOR Fleet One system** includes the following main units:

- SAILOR Fleet One antenna
- SAILOR Fleet One terminal
- Optional: IP Handset

SAILOR Fleet One antenna

The SAILOR Fleet One system uses the SAILOR Fleet One antenna, which is a small size maritime 2-axis stabilized BGAN antenna.

For information on how to install the antenna, see Chapter 2, *Installation*.



SAILOR Fleet One terminal

The SAILOR Fleet One terminal is the controlling unit in the SAILOR Fleet One system. It contains all user interfaces and a power LED indicator and stores configuration data.



SIM card

The terminal has a SIM (Subscriber Identity Module) slot located in the connector panel behind a small cover plate. The terminal requires a dedicated SAILOR Fleet One SIM card, which you get from your airtime provider.

The system requires a SIM card to go online and to access the settings of the terminal. However, using the web interface you can view the Dashboard and upload software without inserting a SIM card.

Router function

The SAILOR Fleet One terminal has a router function which routes traffic between the local network connected to the terminal and network connections on the BGAN network.

The router contains NAT (Network Address Translation) which allows sharing of a public IP address between a number of local network users.

Tools for setup and use

The built-in **web interface** in the terminal is used for easy configuration and daily use. The web interface is accessed from a computer connected to the terminal, using an Internet browser. No installation of software is needed.

For details on the web interface, see *The built-in web interface* on page 51.

The **ThraneLINK Management Application (TMA)** is a Windows program that provides monitoring and software update of connected Cobham SATCOM devices with ThraneLINK support. The devices must be on the same LAN.

If you have an IP Handset (minimum version 1.8) from Cobham SATCOM, it can be used for displaying status, accessing a subset of controls and views and entering the PIN code for the terminal. The IP Handset connects to the LAN interface of the terminal. For information on how to use the IP Handset, see the user manual for the IP Handset (listed in *Related documents* on page v).

Available services

Fleet One is a maritime broadband service providing the following services through the Inmarsat BGAN system:

- **Data connection to the Internet.** A data connection which several users can share simultaneously. The user pays for the amount of data sent and received.
- **Phone connection.** A standard phone connection for making calls over the BGAN network.
- **SMS.** A Short Messaging Service for sending and receiving SMS messages to and from the terminal.

Limitations in services: You may have limited access to some services in some areas. For updated information, ask your service provider. See also *Satellite coverage* on page 5.

Access to services and interfaces

The following table shows which equipment and connectors you can use to access the services listed in the left column.

Service	Connector on terminal	
	Phone	LAN (PoE)
Data	-	Computer or WLAN access point
Standard voice	Analog phone	IP handset or smartphone via WLAN access point
SMS	-	Computer accessing the web interface of the terminal.

Satellite coverage

The coverage map below shows satellite coverage and rate regions for the Fleet One service at the time of writing. For updated information on coverage, see inmarsat.com.



Fleet One coverage

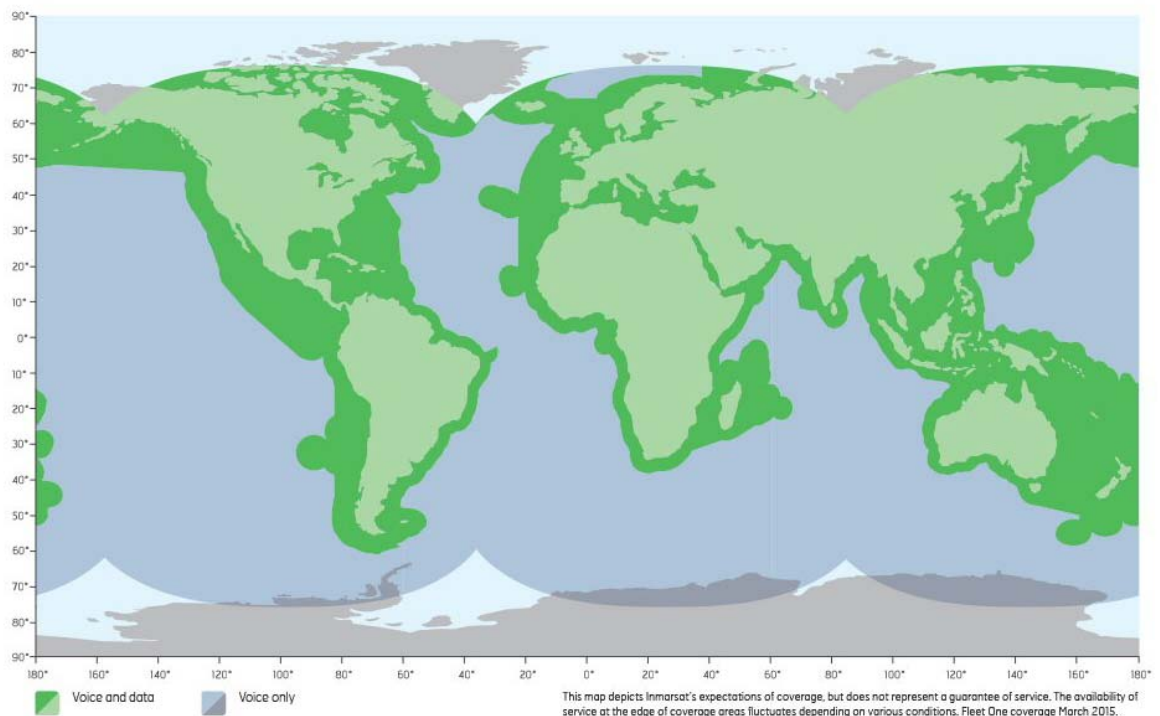

Installation

This chapter describes how to install the SAILOR Fleet One antenna and the SAILOR Fleet One terminal. It has the following sections:

- *Unpack your SAILOR Fleet One*
- *Mounting considerations for the antenna*
- *Antenna mast design*
- *Install the antenna*
- *Mounting considerations for the terminal*
- *Install the terminal*
- *Connect cables*
- *Power cable selection*

Unpack your SAILOR Fleet One

Unpack your SAILOR Fleet One system and check that the following items are present:

- SAILOR Fleet One terminal
- SAILOR Fleet One antenna
- DC power cable (1 m)
- Antenna cable (10 m)
- Ethernet cable (2 m)
- I/O connector
- Mounting bolts and washers for the antenna
- Kit for water protection of antenna connector joint
- Installation guide
- Quick guide
- CD with Installation guide, Quick guide and User & installation manual
- Optional: IP Handset

Inspect all units and parts for possible transport damage.

Mounting considerations for the antenna

When looking for a place to mount the SAILOR Fleet One antenna, make the following considerations:

- Do not place the antenna close to large objects that may block the signal. Place the antenna with free line of sight in all directions to ensure proper reception of the satellite signal.
- Place the antenna in such a way that persons are not exposed to radiation from the antenna. Keep the minimum safety distance. See *Safety summary* on page iii.
- Do not place the antenna within range of other equipment that can interfere with the SAILOR Fleet One.
- Do not place the antenna close to a funnel, as smoke deposits are corrosive. Furthermore, deposits on the radome can degrade performance.
- Do not block the drainage gasket in the bottom centre of the antenna. Leave space below the antenna to allow any water to escape.

The following sections describe the details for the mounting considerations.

Obstructions

The antenna rotates 360° and down to -60° in pitch and roll, to allow for continuous pointing even in heavy sea conditions. Any objects within this field can cause signal degradation.

The amount of degradation depends on the size of the object and the distance from the antenna. As a rule of thumb any object that covers an angle of less than 3° at the antenna has limited effect. The table below gives a guideline for the distance and maximum size of blocking objects in order to avoid degradation.

Distance of object	Maximum size of object
3 m	16 cm
5 m	26 cm
10 m	52 cm
20 m	104 cm

Radiation hazard

The SAILOR Fleet One antenna radiates 16.1 dBW EIRP. This translates to a minimum safety distance of 0.6 m from the antenna while it is transmitting, based on a radiation level of 10 mW/cm².

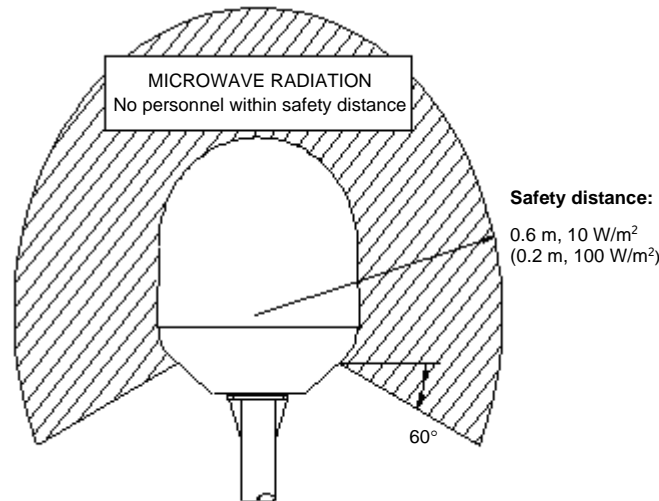

Interference

The antenna must be mounted as far away as possible from the ship's radar and high power radio transmitters (including other Inmarsat based systems), because they may compromise the antenna performance. RF emission from radars might actually damage the antenna.

The SAILOR Fleet One antenna itself may also interfere with other radio systems. Especially other Inmarsat systems and GPS receivers with poor frequency discrimination are vulnerable to the radiation generated by the SAILOR Fleet One antennas.

Radar

It is difficult to give exact guidelines for the minimum distance between a radar and the antenna because radar power, radiation pattern, frequency and pulse length/shape vary from radar to radar. Further, the antenna is typically placed in the near field of the radar antenna and reflections from masts, decks and other items in the vicinity of the radar are different from ship to ship.

However, it is possible to give a few guidelines:

Since a radar radiates a fan beam with a horizontal beam width of a few degrees and a vertical beam width of up to +/- 15°, the worst interference can be avoided by mounting the antenna at a different level – meaning that the antenna is installed minimum 15° above or below the radar antenna. Due to near field effects the benefit of this vertical separation could be reduced at short distances (below approximately 10 m) between radar antenna and the SAILOR Fleet One antenna. Therefore it is recommended to ensure as much vertical separation as possible when the SAILOR Fleet One antenna has to be placed close to a radar antenna.

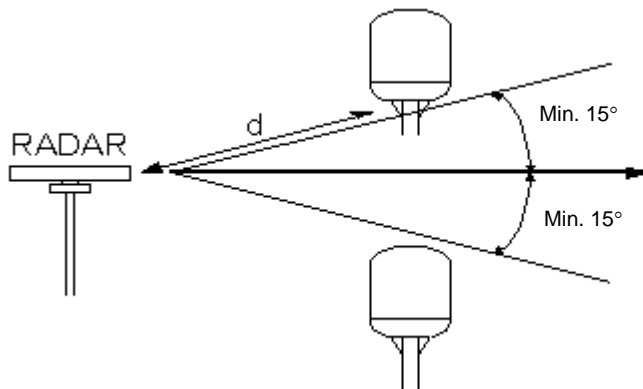

Radar distance

The minimum acceptable separation ($d_{min.}$) between a radar and the antenna is determined by the radar wavelength/frequency and the power emitted by the radar. The tables below show some “rule of thumb” minimum separation distances as a function of radar power at X and S band. If the $d_{min.}$ separation listed below is applied, antenna damage is normally avoided.

“ $d_{min.}$ ” is defined as the shortest distance between the radar antenna (in any position) and the surface of the SAILOR Fleet One antenna.

X-band (~ 3 cm / 10 GHz) damage distance		
Radar power	$d_{min.}$ at 15° vertical separation	$d_{min.}$ at 60° vertical separation
0 – 10 kW	0.8 m	0.4 m
30 kW	2.4 m	1.2 m
50 kW	4.0 m	2.0 m

S-band (~ 10 cm / 3 GHz) damage distance		
Radar power	$d_{min.}$ at 30° vertical separation	$d_{min.}$ at 75° vertical separation
0 – 10 kW	0.4 m	0.2 m
30 kW	1.0 m	0.5 m
50 kW	2.0 m	1.0 m

The separation distance for C-band (4-8 GHz) radars should generally be the same as for X-band radars.

Radar interference

Even at distances greater than “d min.” in the previous section the radar might still be able to degrade the performance of the SAILOR Fleet One system.

The presence of one or more X-band radars within a radius up to 100 m could cause a minor degradation of the signal-to-noise ratio during high speed and data calls. The degradation will be most significant at high radar pulse repetition rates.

As long as receiving conditions are favorable, this limited degradation is without importance. However, if receiving conditions are poor – e.g. due to objects blocking the signal path, heavy rainfall or icing, low satellite elevation and violent ship movements – the small extra degradation due to the radar(s) could cause poor call quality. A voice call might become noisy or fail while a data connection might decrease in speed and performance.

The presence of S-band radar(s) is unlikely to cause any performance degradation – as long as the minimum distances (d min.) listed in the previous section are applied.

It is strongly recommended that interference free operation is verified experimentally before the installation is finalized.



CAUTION! The antenna must never be installed closer to a radar than “d min.” - even if experiments show that interference free operation can be obtained at shorter distances than “d min.” in the previous section.

Other Inmarsat systems

Recommended minimum safe distance to other Inmarsat antennas is 10 m.

GPS receivers

Good quality GPS receivers will work properly very close to the antenna - typically down to one meter outside the main beam, and down to a few meters inside the main beam. However, simple GPS receivers with poor frequency discrimination could be affected at longer range (typically 10 m). It is always recommended to test the GPS performance before the installation is finalized.

VSAT systems

For optimum performance we recommend a minimum distance of 3 meters from the BGAN antenna to VSAT antennas.

Auxiliary Terrestrial Component (ATC)

The SAILOR Fleet One system is resilient to ATC base stations (future terrestrial mobile systems) that operate inside the Inmarsat band and that may be located near the coast.

Other transmitters

See *Minimum distance to transmitters* on page 115 in Appendix A for minimum recommended distance to transmitters in the frequency range below 1000 MHz.

Antenna mast design

The antenna mast must be designed to carry the weight of the antenna unit, which is approximately 3.9 kg (+ 1.1 kg for the mast mount kit)

The mast must also be able to withstand onboard vibrations and wind forces up to 108 knots on the radome, even in icing conditions.

Antenna mast mounting

Mast mount kit:

The top of the SAILOR Fleet One antenna mast should be fitted with the dedicated mounting kit available from Cobham SATCOM.

Assemble the mast mount kit according to the assembly instruction included with the kit.

The mast mount kit interfaces to a 1½" pipe (OD 48.3 mm). If the supplied plastic sleeve is omitted, a maximum diameter OD of 52 mm can be used.

Custom mast mounting:

For a custom mast mounting, use 4 M6 bolts (A4) in the threaded bushings on the 175.4 mm diameter circle in the bottom of the antenna. The length of the bolts must be such that they engage into the bushings of the radome with min. 6 mm and max. 12 mm.

Important | Do not block the drainage hole in the centre bottom of the antenna.

Drill a hole for the cable in the mast flange or use an angled connector.

Mast length and diameter

The placement of the antenna must ensure a rigid structural connection to the hull or structure of the ship. Parts of the ship with heavy resonant vibrations are not suitable places for the antenna.

A small platform or short mast provides rigid support for the antenna fastening bolts and a rigid interface to the ship.

If it is necessary to use a tall mast, use the table on page 12 to obtain the maximum free length of the mast. Note that these values depend on rigid antenna-ship interfaces. The cross-sectional properties and the corresponding maximum free length give a natural frequency above 30 Hz.

It is recommended to shorten the mast length as much as possible to obtain higher frequencies. Alternatively, mount stays or wires to stabilize the mast further.

Note | The table in the next section lists the values for **steel masts**.
For **aluminium masts**, the free mast length is reduced to 75% of the values for steel.

High masts or installations on ships with high vibration levels should be further stabilized by stays or wires from the mast flange. Also mount vibration isolators between the flange and the radome. For SAILOR Fleet One, the vibration isolators are included in the Mast mount kit.

Note

Stays and rigid masts can still not prevent vertical vibration if the mast is attached to a deck plate that is not rigid. Make every effort to mount the mast on a surface that is well supported by ribs. If this is not possible, provide extra deck plate propping.

Antenna mast length

The below table shows the values for a **SAILOR Fleet One** antenna mast without stays or wires. Note that these values are only guidelines - always consider the environment and characteristics of the ship before deciding on the mast dimensions.

The mast mount kit interfaces to a 1½" tube (OD 48.3 mm - absolute maximum OD 52 mm). Masts with larger diameters must be tapered and the upper part of the tube (approximately 50 mm) must have a diameter of 1½".

OD (mm)	Wall Thickness (mm)	Weight (kg/m)	Inertia (X10 ⁶ mm ⁴)	Max. free mast length (steel), m
48.3	3.25	3.61	0.117	< 0.6
48.3	4.05	4.43	0.139	
50	3.00	3.48	0.123	
60.3	3.65	5.10	0.262	< 0.8
60.3	4.50	6.17	0.309	
76.1	3.65	6.80	0.547	< 1.0
76.1	4.50	7.90	0.651	
88.9	4.05	8.47	0.974	< 1.1
88.9	4.85	10.10	1.140	

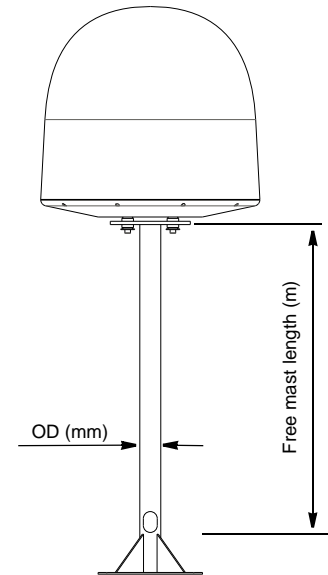

Install the antenna

Ground the antenna

You may ground the antenna using the mounting bolts.

If the antenna cannot or should not be electrically connected directly to the mounting surface, you can use a separate grounding cable to make the connection between the antenna and the common ground to which the terminal is also connected. For example, you can connect a separate grounding cable when vibration isolators are used at the mounting bolts.

To obtain a good ground connection, the metal underneath the head of **at least** one bolt must be clean of insulating protective coating and a serrated washer should be used. After tightening the bolts we recommend that you seal the area suitably in order to avoid corrosion of the grounding point.

Use stainless steel bolts and washers.

Antenna cables

Guidelines

A coaxial cable for connection between the antenna and terminal is delivered with the system. If you need a different cable, make sure that the cable meets the requirements. Preferably choose one of the cable types in *Recommended antenna cables* below.

Select a suitable area for installation of the terminal, antenna and cradle. Where the cables are exposed to mechanical wear - on deck, through bulkheads, etc. - protect the cables with steel pipes. Otherwise, follow standard procedures for cabling in ship installations.

The maximum allowed RF-loss in the antenna cable is 20 dB at 1660 MHz. This is to ensure the performance of the system.

Recommended antenna cables

The table below shows recommended cable types and maximum cable lengths for SAILOR Fleet One.

Cable Type	Absolute maximum length
G02232-D	6 m
RG223-U	25 m
RG214/U	50 m
S 07272B-05	95 m

Check in the data sheet from the cable supplier that both the RF-attenuation and the DC-resistance are kept within the maximum specified values:

- Antenna cable RF-attenuation at 1660 MHz: max. 20 dB incl. connector.

- Antenna cable modem-attenuation at 54 MHz: max. 4 dB.
Antenna cable modem-attenuation at 36 MHz: max. 3 dB.
- Antenna cable loop DC-resistance max: 1 Ohm.

Also ensure that the specified minimum bending radius is respected. If this is not the case, the loss in the cable will increase. Check the instructions from the cable supplier.

Important mounting notes

Water intrusion

After having connected the antenna cable to the antenna, ensure that the connector assembly is properly protected against seawater and corrosion. As a minimum, use self-amalgamating rubber.

If possible, install the radome such that direct spray of sea water is avoided.

It is recommended not to use pneumatic tools for cleaning the radome, especially at a short distance and directly at the split between top and bottom.

Note that the SAILOR Fleet One antenna is drained for condensation through the gasket in the bottom centre. Make sure the requirements to drainage are met. See the next section *Condensation*.

Condensation

In some cases there will be condensation inside the radome. The gasket in the bottom centre of the SAILOR Fleet One antenna is designed to lead any water away from the radome. Make sure the drainage gasket is not blocked when you mount the antenna.

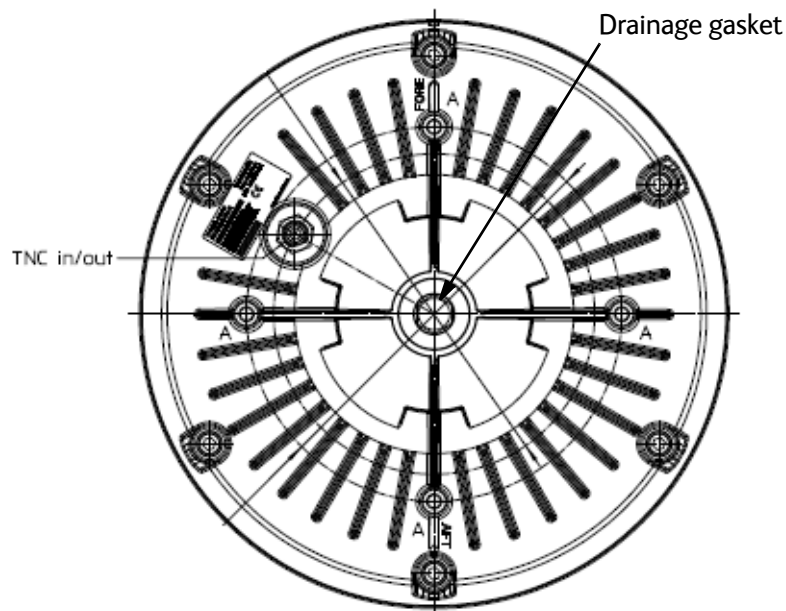

Mount the antenna

The radome can now be installed on the ship with 4 stainless steel bolts fastened to the hull or to a mast.

For information on mast mounting, see *Antenna mast design* on page 11.

To mount the antenna on the hull

Make sure the antenna has line of sight to the satellites. When the antenna is mounted directly on the hull, it may be difficult to obtain line of sight, especially down to -60° , which is the maximum rotation angle (pitch and roll) for the SAILOR Fleet One antenna.

Important Do not block the drainage hole in the centre bottom of the antenna.

Make sure to leave room for the connector and cable under the antenna.

Mount the antenna with 4 M6 bolts into the threaded bushings in the bottom of the antenna (marked A in the drawing below).

The bolt thread must not penetrate more than 12 mm (or 8 turns of the bolt) - and not less than 6 mm (or 4 turns of the bolt)- into the threaded part of the bushings in the radome. Fasten the bolts with 7-8 Nm torque.

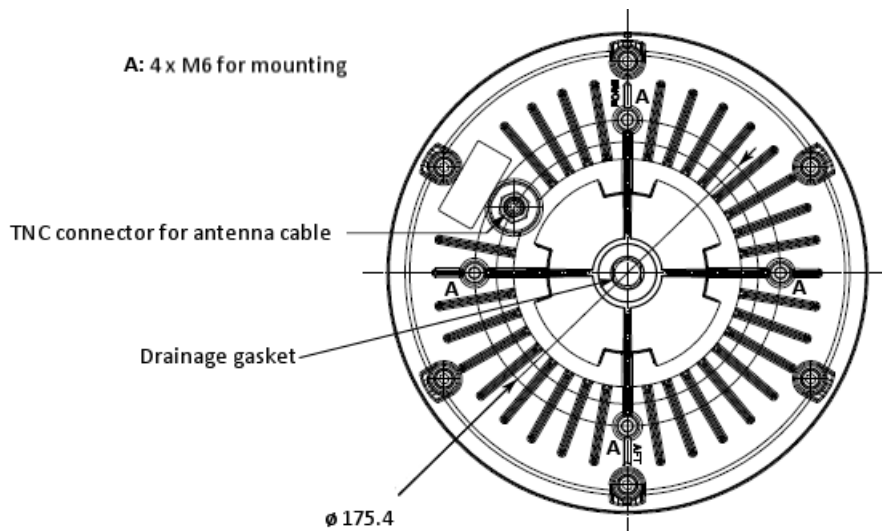

Mounting considerations for the terminal

Where to place the terminal

Temperature conditions

The terminal must be placed in a ventilated area with free space around all sides of the unit, except the bottom side.

Ambient temperature range is $-25\text{ }^{\circ}\text{C}$ to $+55\text{ }^{\circ}\text{C}$.

If the terminal is installed in a location where the ambient temperature may exceed $45\text{ }^{\circ}\text{C}$, we recommend placing the terminal where unintentional contact is avoided. If the maximum ambient temperature does not exceed $45\text{ }^{\circ}\text{C}$, the terminal can be placed in a public area.

Grounding access

The terminal is designed with a case for bulkhead or desktop installation. The case is equipped with mounting brackets, making it possible to secure the unit on a bulkhead.

**Important**

The terminal must be placed in an area where access to the hull or equivalent grounding can be reached within 0.5 m.

Install the terminal

Ground the terminal

Antenna cable

The antenna ground is connected to the terminal ground by means of the coax cable with a TNC connector at both ends.

For information on antenna grounding, see *Ground the antenna* on page 13.

Ground stud

To ensure that the terminal is grounded – also if the cable is disconnected from the terminal, connect an extra ground wire to the ground stud on the terminal. This ground wire must be a heavy wire or braid cable with a larger diameter than the coax cable. The ground stud is located next to the power switch.



Ground connection through the mounting surface

In addition to the ground stud you may connect the terminal chassis to ground through the mounting surface. Make sure you have a good electrical connection between the terminal chassis and the mounting surface.

1. Remove the four rubber feet from the terminal.

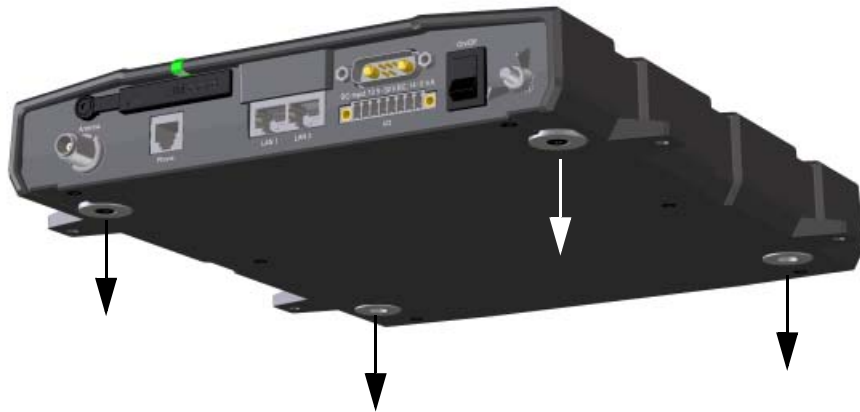

2. Attach the terminal to the mounting surface using four screws through the mounting surface and into the threaded bushings on the underneath of the terminal.

Mount the Basic cable support (optional)

If you want to use a cable support for your terminal, you can acquire a Basic cable support (“Accessories kit F/ Terminal”, spare part no. S-673738A) from your distributor.

When mounted on the terminal the Basic cable support offers a number of holders to which you can secure the cables from the terminal, using cable strips.

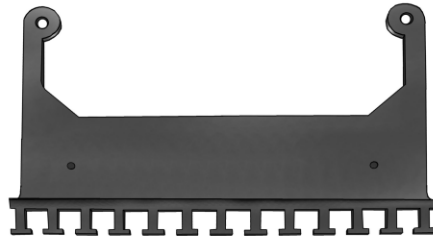

To mount the Basic cable support, do as follows:

1. Remove the two rubber washers from the bottom of the terminal at the connector panel end. The threaded bushings underneath the rubber washers are used for mounting the cable support.



2. Fasten the Basic cable support to the terminal using two M4 x 6 mm countersunk screws.



3. Install the terminal as described in *To install the terminal on a bulkhead* on page 20 or *To install the terminal on a desktop* on page 20.

To install the terminal on a bulkhead

Terminal with no cable support

Do as follows to mount the terminal on a bulkhead:

1. Insert four screws through the mounting holes and into the mounting surface.

Important

This mounting method cannot be used for grounding. If you are using the mounting surface for grounding, you must use the threaded bushings on the underneath of the terminal instead. See *Ground connection through the mounting surface* on page 18.



2. Connect all cables.

Terminal with Basic cable support

First mount the Basic cable support on the terminal as described in *Mount the Basic cable support (optional)* on page 19.

1. Mount the terminal with the Basic cable support on the bulkhead by inserting four screws through the holes in the mounting bracket and into the mounting surface.
2. Connect all cables.
3. Secure the cables to the cable support using cable strips.

To install the terminal on a desktop

Four rubber feet make the terminal well suited for desktop installation. Simply place the terminal on a desktop and connect all cables.

If required, fasten the terminal to the desktop with four screws, as described in the previous section *To install the terminal on a bulkhead*.

Make sure that the grounding requirements are met. See *Ground the terminal* on page 17.

Connect cables

The connector panel

The connector panel has the following connectors:



- 1 Antenna connector (TNC)
- 1 Phone connector
- 2 LAN connectors with Power over Ethernet (PoE)
- 1 DC power input connector for connection to 10.5-32 V DC, with optional remote on/off
- 1 Input/Output connector with 5 inputs/outputs for external control or signalling
- 1 ground stud with wing nut

For information on how to connect to a specific interface, see the next sections.

Antenna interface on the terminal

The antenna interface on the terminal connects to the SAILOR Fleet One antenna. The connector on the terminal is a TNC female connector. An antenna cable (10 m) is included in the delivery.



To connect the antenna to the terminal

1. Connect the antenna cable between the Antenna connector on the terminal and the connector on the underneath of the antenna.
2. Where the cables are exposed to mechanical wear - on deck, through bulkheads, etc. - protect the cables with steel pipes. Otherwise, follow standard procedures for cabling in ship installations.

For information on alternative cables and how to install and connect the antenna, see *Install the antenna* on page 13.

DC power input

The DC power input for the terminal is a 10.5 - 32 V DC; 11.5 A - 4 A input with a remote on/off function. The input is protected against reverse polarity.

There are different options for the power supply:

- The 24 V DC ship supply provides power for the terminal.
- A 12 V DC supply provides power for the terminal. Note that the maximum allowed source impedance is much lower for a 12 V DC supply than for a 24 V DC supply. Also, the total output power available for Power over Ethernet is limited when the power supply is 12 V DC.
- A 230 V AC supply provides power through an AC/DC power supply.

Be aware of high start-up peak current: 20 A at 24 V, 5 ms.

The terminal is equipped with an internal 20 A Fuse, so no external fuse is necessary in order to protect the terminal. However, in order to avoid short circuit in the power cable/connector, the ship's DC outlet should be protected by a 30 A fuse or circuit breaker.

Pinout

The power connector is a Mixed D-Sub connector 7W2, control pin male/ power pin male. The below table shows the pinout for the connector and the colors of the corresponding wires.

Pin number	Pin function	Color of wire in power cable
A1	Vin+	Red (thick)
A2	Vin-	Black (thick)
1	Not connected	Black (thin)
2	Remote on/off	Green
3	Not connected	Brown
4	Not connected	Red (thin)
5	Remote on/off	Orange

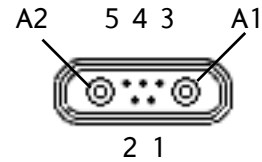

To connect DC power to the terminal

Do as follows to connect the power cable:

1. Connect the red (+) and black (-) wires of the supplied power cable to the ship's 24 V DC supply according to the recommendations in the previous sections.

Note If the supplied power cable is not long enough, see *Power cable selection* on page 34.

2. Connect the D-sub connector on the power cable to the DC input connector on the terminal.



If you need a remote on/off function, you may use one of the following options:

- Connect the Remote on/off wires in the power cable to a remote switch. For further information, see *To connect a remote on/off switch* on the next page.
- Connect the ignition pins in the I/O connector to the ignition of your vessel. For further information, see *To connect to the ignition* on the next page.

For specifications of the DC input on the terminal, see *Power input* on page 118 in *Technical specifications*.

To connect a remote on/off switch

The terminal has a remote on/off function. When the terminal power switch is in the “on” position you can remote-control the power function.

By installing a switch that can short-circuit the “Remote on/off” pins (2 and 5) in the power connector you can power the terminal on or off with this remote switch.

When pins 2 and 5 are not short-circuited and valid input power is present, the terminal is powered on, provided the Power switch is in the “on” position.

For pinout for the power connector and a description of the wire colors in the power cable, see *Pinout* on page 23.

For information on the standby current when the remote on/off switch is off, refer to *Standby current* on page 118 in *Technical specifications*.

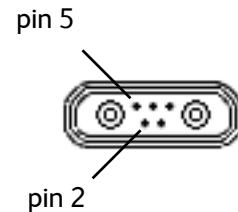

To connect to the ignition

The terminal has an ignition function. When this function is used, the terminal switches on/off when you start/stop the engine of your vessel (provided the power switch on the terminal is on).

Note

You must set up the ignition function in the terminal. For details, see *To configure the I/O interface* on page 72.

To implement the ignition function, connect the appropriate pin in the I/O connector to the ignition key switch:

- Active high (default): Connect pin 5 permanently to ground. When the ignition is on, connect pin 8 to positive DC voltage (10.5-32 V DC). When the ignition is off, disconnect pin 8 from the positive DC voltage.
- Active low: Connect pin 8 permanently to positive DC voltage (10.5-32 VDC). When the ignition is on, connect pin 5 to ground (< 1.2 V DC). When the ignition is off, disconnect pin 5 from ground.

For pinout and default functions, see *I/O interface* on page 28.

For information on the standby current when the ignition power is off, see *Standby current* on page 118 in *Technical specifications*.

Phone interface

The terminal has one RJ-11 connector for connecting an analog phone.



Pinout

The Phone connector is an RJ-11, 6/4 female connector. The table and figure below show the connector outline and pin assignments.

Pin number	Pin function
1	-
2	Not connected
3	Tip
4	Ring
5	Not connected
6	-

RJ-11 female connector

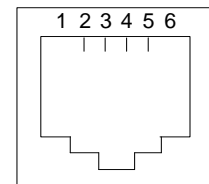

To connect an analog phone

Connect your analog phone to the terminal using a standard phone cable with an RJ-11 male connector.

LAN interface

The terminal has two Ethernet LAN ports with Power over Ethernet (PoE). The PoE standard for the Ethernet ports is IEEE 802.3af, and the connectors are RJ-45 connectors.



Power over Ethernet (PoE)

The LAN connectors have PoE, which means they can be used to supply power to connected equipment, e.g. IP handsets. One power supply powers both interfaces with a floating 48 V DC supply (44 - 57 V DC). Therefore, the interfaces are not galvanically separated from each other. Both Tx signals are DC connected to the Positive PoE Voltage and both Rx signals to the Negative PoE Voltage.

Note Equipment connected to the LAN (PoE) connectors must comply with the PoE standard IEEE 802.3af.

The total output power from the interfaces is 32 W. Both interfaces can support devices of power class 1, 2 and 3 (4, 7 and 15.4 Watt), as long as the total power consumption does not exceed the above limits.

In case of power hold-up (failure on input power), PoE will be turned off.

Pinout

The figure and table below show the connector outline and pin assignments.

Pin number	Pin function
1	TxD+ input (positive PoE)
2	TxD-input (positive PoE)
3	RxD+ output (negative PoE)
4	Not connected
5	Not connected
6	RxD- output (negative PoE)
7	Not connected
8	Not connected

RJ-45 female connector

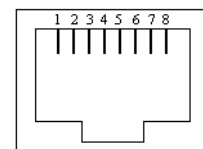

To connect a wireless LAN access point

The SAILOR Fleet One does not have a built-in wireless LAN (WLAN) access point. If you want to use WLAN to access the SAILOR Fleet One you must connect an external WLAN access point. The WLAN access point must be without NAT (Network Address Translation).

Connect a LAN cable between your WLAN access point and one of the LAN connectors on the terminal.

Refer to the documentation for your WLAN access point for information on configuration.

To connect an IP handset to the LAN interface

To connect an IP handset to the terminal, do as follows:

Connect the cable from the IP handset to one of the LAN connectors on the terminal, preferably port 1. In case of insufficient power to the LAN PoE the LAN ports are prioritised, so that port 1 is the last to be shut down.¹

Note that the handset and terminal must be set up to be able to communicate with each other. For further information, refer to *Configuration for making calls* on page 40 and the user manual for the IP handset.

The maximum length of the cable between the IP handset and terminal is 80 m.

Note

If you insert a switch or similar between the cradle and the terminal, or if you are using a 3rd party IP handset, make sure that it conforms to the industry standard IEEE 802.3 af (using data pairs).

-
1. Both LAN interfaces can support devices of power class 1, 2 and 3 (4, 7 and 15.4 Watt), as long as the total power consumption does not exceed 32 W. If the limit is exceeded, the LAN ports are prioritised so that LAN port 1 has the highest priority and port 2 is closed down. In case of power hold-up (failure on input power), PoE will be turned off completely.

I/O interface

The terminal has an I/O connector with 5 configurable inputs/outputs



The connector is a WieCon Type 8513S connector.
A matching connector is included in the delivery.



Pinout

The figure and table below show the connector outline and pin assignments.²

Pin number	Default configuration
1	Ringer output
2	Warning/Error output
3	Indicator for data connection, output
4	Control data connection on/off, input
5	Ignition input
6	Chassis GND
7	DC out, 9-15 VDC, 50 mA
8	DC in (Ignition input)

WieCon Type 8513S connector

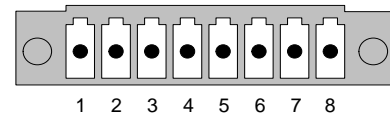

² The default functions of the I/O pins are described in the next section.

I/O pin functions

Output pins 1,2 and 3:

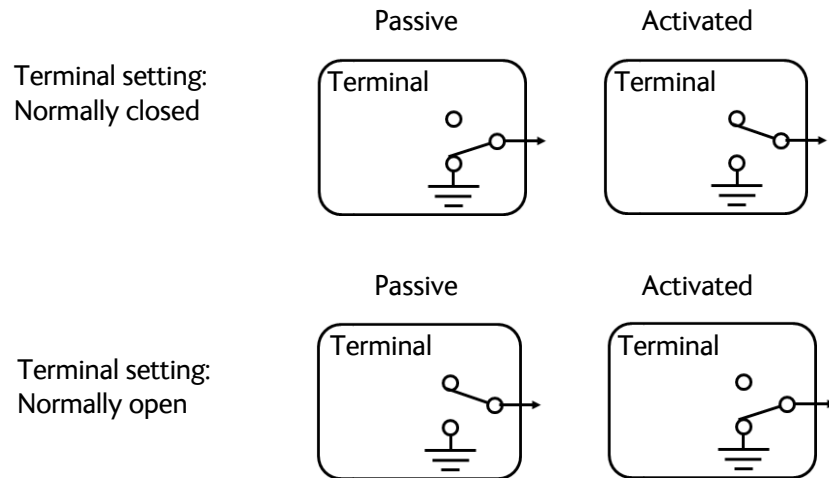

Pin 1: Ringer output.

Pin 1 acts as a built-in switch in the terminal. You can configure Pin 1 to be Normally closed or Normally open, using the web interface.

- Normally closed (default):
The internal switch at pin 1 is normally closed (pin 1 is connected to ground). When the terminal is notified of an incoming call from the satellite interface, the switch opens (no connection to ground). When the call is answered, or the caller gives up and releases the call, the switch is closed again.
- Normally Open:
The internal switch at pin 1 is normally open (no connection to ground). When the terminal is notified of an incoming call from the satellite interface, the switch is closed (pin 1 is connected to ground). When the call is answered, or the caller gives up and releases the call, the switch is opened again.

Pin 2: Warning/Error output.

Pin 2 acts as a built-in switch in the terminal. Pin 2 can be used to provide an external signal that indicates active warning/error condition(s). You can configure pin 2 to be Normally closed or Normally open.

- Normally Closed (default):
The internal switch at pin 2 is normally closed (pin 2 is connected to ground). When an alarm occurs, the switch opens (no connection to ground). The switch is closed again when all warnings/errors are cleared.
- Normally Open:
The internal switch at pin 2 is normally open (no connection to ground). When an alarm occurs, the switch is closed (connected to ground). The switch is opened again when all warnings/errors are cleared.

Pin 3: Indicator for data connection.

Pin 3 can be used as an indicator for active data connections. You can configure pin 3 to Normally closed or Normally open.

- **Normally Closed:**
The internal switch at pin 3 is normally closed (pin 3 is connected to ground). When there is an active data connection, the switch opens (no connection to ground). When the data connection is ended, the switch is closed again (connected to ground).
- **Normally Open (default):**
The internal switch at pin 3 is normally open (no connection to ground). The switch is closed (connected to ground) during active data connections. When the data connection is ended, the switch opens again (no connection to ground).

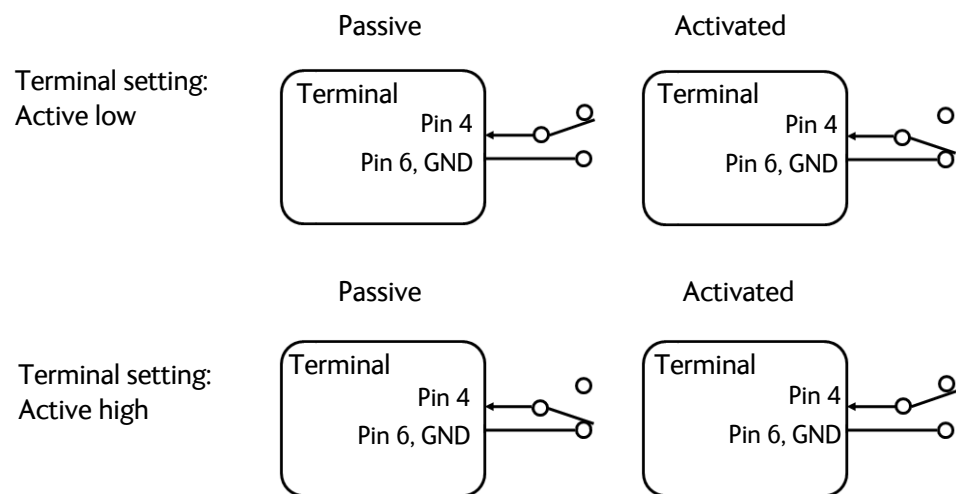
Input pin 4:**Pin 4: Control data connection on/off.**

Activation of this pin causes the system to disable data connections, i.e. to gracefully deactivate any active data connections and to not allow any new data connections to be started. Data connections are not allowed until the pin is deactivated. You can configure pin 4 to Active low or Active high.

- **Active low (default):** Passive state: Leave open. To activate: Connect pin 4 to ground (< 1.2 V DC).
- **Active high:** Passive state: Connect pin 4 to ground (< 1.2 V DC). To activate: Disconnect pin 4 from ground.

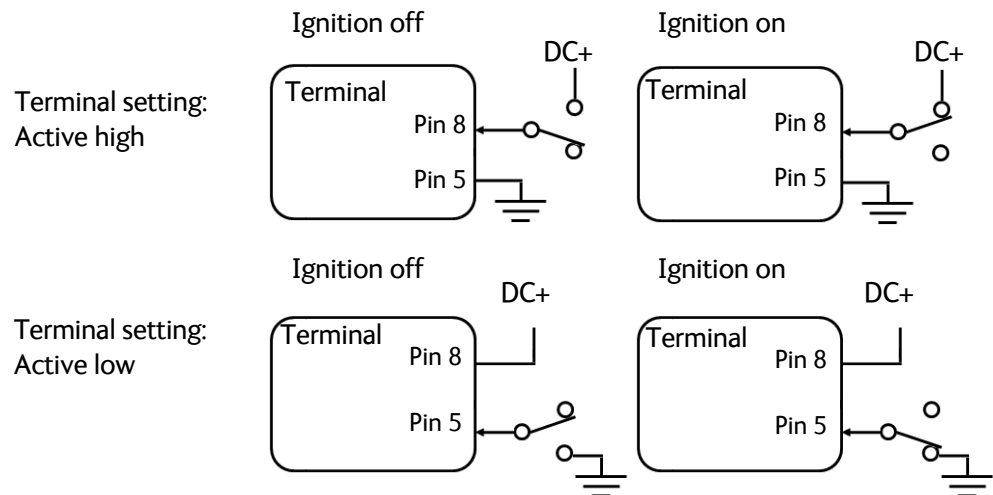
Input pin 5/8 (example):

The functions of the I/O pins are as follows:

Pin 5/8: Ignition input.

The ignition function can be used to turn on/off the terminal by means of an external signal. The external signal that triggers the ignition function can be either positive DC voltage or ground. The ignition function uses pin 5 together with pin 8 (DC in). Connect the appropriate pin to the ignition switch as follows:

- Active high (default): Connect pin 5 permanently to ground. When the ignition is on, connect pin 8 to positive DC voltage (10.5-32 V DC). When the ignition is off, disconnect pin 8 from the positive DC voltage.
- Active low: Connect pin 8 permanently to positive DC voltage (10.5-32 VDC). When the ignition is on, connect pin 5 to ground (< 1.2 V DC). When the ignition is off, disconnect pin 5 from ground.

Pin 6: Ground.

(Non-configurable) Pin 6 can be used as an external connection to ground. Pin 6 is connected to ground inside the terminal.

Pin 7: DC output.

(Non-configurable) Pin 7 can be used as a DC output. The voltage on pin 7 is 9-15 V and the output can supply up to 50 mA. Pin 7 can be used as power supply to a relay, ringer or similar.

The built-in web interface of the terminal offers a page for configuring the I/O pins. For information on how to configure the I/O pins, see *To configure the I/O interface* on page 72.

To connect the data connection status kit (optional)

The optional **SAILOR Fleet One data connection status kit** (part number 403744A-981) can be purchased from your distributor. It consists of:

- A switch for enabling/disabling data connection
- An indicator lamp for showing the status of the data connection

Wires: Additionally you must provide 2 wires for the switch and two wires for the indicator. Specifications for the wires:

- Max. wire diameter: 0.8 mm
- Max wire cross-section for stranded cable: 0.75 mm²

Pin connection: The switch and lamp connect to the I/O connector on the SAILOR Fleet One. The next sections describe how to connect. For details on the I/O pins, see the previous section.

To connect the data connection switch

The data connection switch is used to enable/disable data connection in the SAILOR Fleet One. It is a latched push-button, which contains two switches: One that is normally open and one that is normally closed.

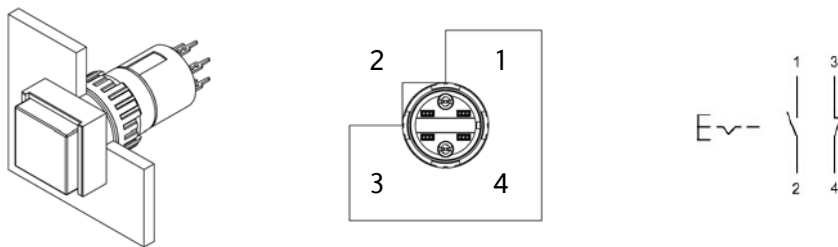

The below procedure is an example with **default configuration of I/O pins**, and the button is used to **disable data connection** when pushed in (latched).

1. If you want to disable data connection when the button is pushed in, solder your wires to pin 1 and 2 on the switch.
2. Mount the switch in the location you want and tighten the nut (max. torque 50 Ncm).
3. Connect the other end of the wires to pin 4 and 6 respectively on the I/O connector.

When you push the button in, the SAILOR Fleet One gracefully deactivates any active data connections and does not allow any new data connections to be started. Data connections are not allowed until the button is released (pushed) again.

Note | A data connection is not necessarily started when you release the button - this depends on whether or not automatic activation is enabled. See *Set up the data connection* on page 67.

To connect the data indicator lamp

The data indicator lamp is used to show if there is an active data connection.

Specifications for the lamp:

- Color: Orange
- Operating voltage: 12 VDC
- Operating current: 7/14 mA \pm 15%

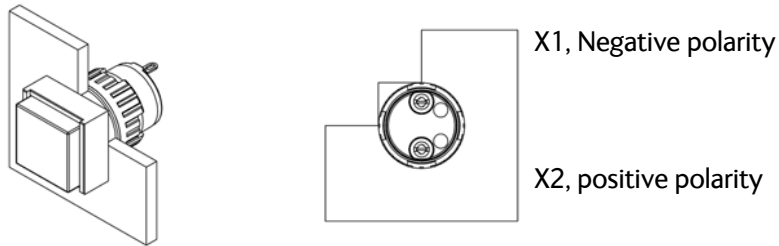

The below procedure is an example with **default configuration of I/O pins**, and the lamp is **on** when a data connection is active.

1. Solder your wires to pin X1 and X2 on the lamp.
2. Mount the lamp in the location you want and tighten the nut (max. torque 50 Ncm).
3. Connect the wire from pin X1 to pin 3 on the I/O connector.
4. Connect the wire from pin X2 to pin 7 on the I/O connector.

When a data connection is active, the lamp is on.

Power cable selection

A power cable of 1 m is supplied with the SAILOR Fleet One terminal. Use this cable if possible. If 1 m is not long enough, you can extend the cable according to the guidelines in this section.

Source impedance

The length of the power cable depends on the type of cable used and the source impedance of the DC power installation in the ship.

The maximum allowed source impedance depends on the usage of the power range of the terminal DC input (10.5 - 32 V DC; 11.5 A - 4 A).

Select a power outlet from the DC system and measure the source impedance of the ship installation as described in the next section.

Note If the total impedance is higher than the limits stated in this section, the terminal may become unstable and start to on/off oscillate.

The total impedance is made up of the source impedance of the ship power supply plus the impedance of connected cables including connectors and joints where cables are extended.

For further recommendations on power cable selection, see *Power cable recommendations* on page 35.

Measuring the ship source impedance

Select a power outlet from the ship 24 V DC or 12 V DC system, and measure the source impedance of the ship installation as described below.

1. Measure the voltage without load (R.var disconnected).
2. Set the current to e.g. 1 A by adjusting R.var.
3. Measure the corresponding voltage change.

Example: 1 A and 50 mV. Source impedance: $50 \text{ mV} / 1 \text{ Amp} = 50 \text{ mOhm}$.

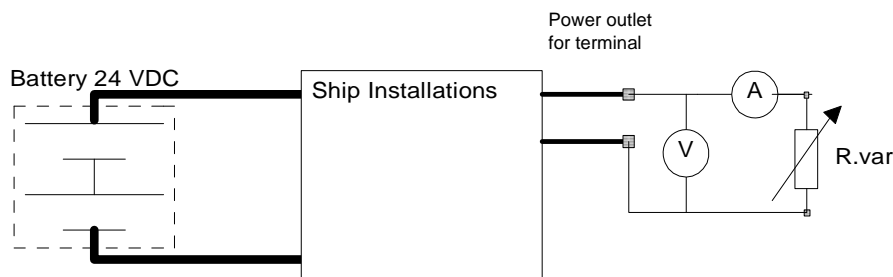

Power cable recommendations

Overview

The terminal is delivered with a power cable, which can be extended according to the recommendations in this section.

- When extending the power cable, positive and negative supply wires must be installed closely together side by side to keep cable inductance low.
- Ensure that cable inductance for the selected cable at the desired length is below the 50 μH requirement.

The power cable contains the following wires:

Color of wire in power cable	Pin number in connector	Function
Red	A1	Vin+
Black	A2	Vin-
Black	1	not connected
Green	2	Remote on/off
Brown	3	not connected
Red	4	not connected
Orange	5	Remote on/off

Calculating the maximum power cable extension

For 24 V DC operation, the total impedance must be max. 500 mOhm, including the source impedance in the ship installation.

For 12 V DC operation, the total impedance must be max. 85 mOhm, including the source impedance in the ship installation.

The total impedance is made up of the following:

- the source impedance in the ship installation
- the cable impedance of the supplied power cable, including the impedance in the joint of the two cables. In the following example, the impedance of the cable and joint is set to 10 mOhm (1 m power cable). Note that if the cable length or type is changed, the impedance will change accordingly.
- the extension cable impedance.

To calculate the maximum cable extension, do as follows:

1. First measure the source impedance in the ship installation as shown in *Measuring the ship source impedance* on page 34.
2. Then find the impedance per meter for the cable type you are going to use.
For 4 mm²/AWG 11, the value is 4 mOhm/m at 20 °C
For 1.5 mm²/AWG 15, the value is 10 mOhm/m at 20 °C
For other cable types, refer to the data sheet for the cable.
3. Calculate the maximum allowed impedance in the extension cable as follows:
Max. allowed impedance in extension cable = max. total impedance - (measured source impedance + impedance of the supplied cable).
4. Then calculate the max. extension cable length as follows:

$$\text{Max. length} = 0.5 \times \frac{\text{Max impedance in extension cable}}{\text{impedance per meter}}$$

The length is multiplied by 0.5 above because there are two conductors in the cable.

Example:

Ship supply voltage: 12 V DC

Ship source impedance (measured): 50 mOhm

Extension cable type: 4 mm² (AWG 11)

$$\text{Max. cable extension} = 0,5 \times \frac{85m\Omega - (50m\Omega + 10m\Omega)}{4m\Omega/m} = 3,12m$$

In this case, the power cable can be extended with up to 3.12 m.

If you need a longer cable, you can double the maximum allowed length by connecting two cables instead of one, or you can use a cable with a larger diameter.

Get started

This chapter describes how to start up the system and make the first call or data session. It has the following sections:

- *Start up the SAILOR Fleet One*
- *Connect a smartphone*
- *Connect an IP handset*
- *Connect a computer*
- *Make a call*
- *Connect to the Internet*

Start up the SAILOR Fleet One

Insert the SIM card

Note that the SAILOR Fleet One terminal requires a SIM card dedicated to the Fleet One service. The terminal can only access the BGAN network when the right type of SIM card is installed. The SIM card is provided by your airtime provider.

To insert the SIM card, do as follows:

1. Open the SIM cover in the left side of the connector panel.
2. Insert the SIM card into the SIM slot. Place the card with the chip side facing up as shown.
3. Press gently until it clicks.
4. Slide the lock in front of the SIM card.
5. Close the cover for the SIM slot.

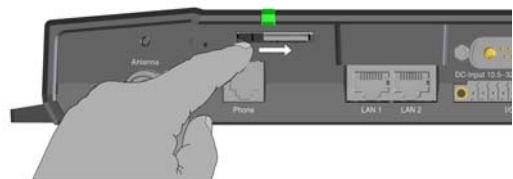

Power up the SAILOR Fleet One

Power switch

To switch on the terminal, tip the On/Off switch.

It normally takes a few seconds for the terminal to switch on.



Remote on/off switch

If an external switch is connected to the remote on/off pins in the DC connector, you may leave the power switch in the connector panel in the “on” position and use the remote switch to turn the terminal on and off. When the remote switch is off, the terminal is off. However, if you leave the power switch on the terminal in the “on” position, you can always switch the terminal back on with the remote switch. The standby current when the remote switch is off is max. 2 mA. For further information on how to connect a remote on/off switch, see *To connect a remote on/off switch* on page 24.

Ignition system

Normally the ignition function is not used in maritime installations. Instead you may want to use the remote on/off function described in the previous section.

If you have connected the ignition system of your vessel to the I/O connector, you may leave the power switch in the “on” position and the terminal will switch on/off when you start/stop the engine of your vessel.

When the engine is stopped the terminal is in standby mode, meaning that only the primary parts of the system are kept alive. The standby current is max. 15 mA when the ignition is off. For information on how to connect to the ignition, refer to *To connect to the ignition* on page 24.

You must set up the ignition function in the web interface. For further information, see *To configure the I/O interface* on page 72.

SIM PIN

By default, a SIM PIN is **not** required.

Using the built-in web interface of the terminal with an administrator password, you can apply a SIM PIN, so that you have to enter a PIN code to access the SAILOR Fleet One system and the BGAN satellite network. For details, see *Configure the SIM PIN* on page 81

If a PIN is required, you can enter the PIN using an analog phone, an IP Handset or the web interface. For details, see *SIM PIN* on page 63.

Register with the BGAN network

When the terminal is switched on and the SIM PIN is accepted (if required), the SAILOR Fleet One automatically starts the registration procedure on the BGAN network.

Note The registration procedure may take several minutes.

You can monitor the registration procedure in two ways.

- Connect the IP Handset from Cobham SATCOM and watch the procedure in the display.
- Connect a computer, access the built-in web interface of the terminal and watch the **Status** field in the **DASHBOARD**. For details, see *Dashboard* on page 54.

The normal startup procedure is shown as follows:

1. **Searching.** The terminal has instructed the antenna to search for the BGAN signal.
2. **Registering.** The terminal is attempting to register with the Satellite Access Station (SAS).
3. **Ready.** The terminal has registered and attached to the SAS and is ready to accept a service request (a call or a data session).

Connect a smartphone

Wireless access point

The SAILOR Fleet One does not have a built-in WLAN access point. If you want to use wireless devices with your SAILOR Fleet One you must connect an external WLAN access point to the LAN interface. Refer to the documentation for your WLAN access point for details on how to configure and connect it.



Configuration for making calls

Once connected to the SAILOR Fleet One through your external WLAN access point, your smartphone can be set up to make and receive calls over the BGAN network using the SAILOR Fleet One phone number. You can also make local calls to other phones connected to the SAILOR Fleet One.

Note Make sure your smartphone has an integrated SIP client. If you do not have a SIP client, you can find SIP applications available for download on the Internet.

If it is the first time you connect your smartphone to the SAILOR Fleet One for making calls, you must first set up the SIP server details in your smartphone. For information how, see the user documentation for your smartphone and the SIP application. You may be asked to enter some of the following details:

- SIP server address and port:
Default address: 192.168.0.1, Port: 5060
- User name:
Local no. in SAILOR Fleet One (0501 to 0504)
- Password:
Default the same as the user name. If you change it, remember to change it in the IP handset settings of the SAILOR Fleet One web interface as well.
- Codec priority:
Highest priority codec type: G.711

You must set up the user name and password in the web interface of the SAILOR Fleet One to match the IP handset settings. See *Connecting and configuring IP handsets or smartphones* on page 70.

Note Every IP handset and smartphone connected to the SAILOR Fleet One must be set up with a unique number (user name).

To make calls with your smartphone

Once you have connected the WLAN access point to the LAN interface of the SAILOR Fleet One, configured the access point, and configured your SIP settings as described in the previous section, all you have to do is start your SIP application on your smartphone.

You should now be ready to make and receive phone calls over the BGAN satellite network.

For details on how to make calls, see *Phone calls* on page 45.

Connect an IP handset

Power supply (PoE)

The SAILOR Fleet One can provide power to your IP handset through the LAN interface, using Power over Ethernet (PoE).

We recommend connecting your IP handset to LAN 1, because in case the power limit is exceeded, LAN 2 is closed down first.

To connect the IP Handset from Cobham SATCOM

Note By default, an IP Handset from Cobham SATCOM connected to the LAN interface on the terminal is automatically registered in the terminal and assigned the first available local number.

Connect your IP Handset to LAN 1 on the SAILOR Fleet One terminal. The IP Handset starts up automatically when it is connected.



When the display shows  in the upper right corner, the IP Handset is ready for making calls.

To connect a 3rd party IP handset

Connect the IP handset to LAN 1 on the SAILOR Fleet One terminal and set up the SIP server details in your IP handset and the terminal's built-in web interface as described in *Configuration for making calls* on page 40.

Connect an analog phone

Connect your analog phone to the Phone connector on the terminal using a standard phone cable with an RJ-11 male connector.



Connect a computer

To connect to the LAN interface

For the LAN interface to work without any further setup, the connected computer must be set up to obtain an IP address and a DNS server address automatically. If in doubt, check your network connection settings on the computer.

Connect a LAN cable between your computer and one of the LAN connectors on the SAILOR Fleet One terminal.



For information on how to access the Internet, see *Connect to the Internet* on page 44.

To connect through a wireless access point

The SAILOR Fleet One does not have a built-in wireless LAN (WLAN) access point. If you want to use wireless devices with your SAILOR Fleet One you must connect an external WLAN access point to the LAN interface as described in *Wireless access point* on page 39. Refer to the documentation for your WLAN access point for details on configuration.

Make a call

When the terminal is registered with the BGAN network you are ready to make or receive the first call. The following sections provide a short guide to making calls. For more detailed information, see *Phone calls* on page 45.

To make a call from the SAILOR Fleet One

To make a call from a phone connected to the terminal, dial

00 <country code> <phone number>

Example:To call Cobham SATCOM in Denmark (+45 39558800) from an analog phone, dial
00 45 39558800

Note

If you are calling from an analog phone, dial # after the number to activate the call.

To make a call to the SAILOR Fleet One

To make a call to a phone connected to the terminal, dial

+ <SAILOR Fleet One number>

- + is the international call prefix¹ used in front of the country code for international calls.
- **SAILOR Fleet One number:** The number of the SAILOR Fleet One terminal you are calling. The first part of the number is always 870, which is the “country code” for the BGAN system.

Example:If you are calling from Denmark and your SAILOR Fleet One number is 870772420567, dial **00 870 772420567**.

If the SAILOR Fleet One number is listed in the web interface, you can look it up by selecting **PHONE BOOK > Mobile numbers**. See *Phone number of the SAILOR Fleet One* on page 58. If the numbers are not listed, refer to the documents provided with your airtime subscription.

1. The plus sign indicates the code required to dial out of one's country code area, such as 00 in most of Europe, 011 in the United States, and other short codes in other parts of the world.

Connect to the Internet

By default, the terminal does **not** automatically connect to the Internet when you connect your computer or other equipment to the LAN interface. You must activate your connection from the Dashboard in the web interface or from an IP Handset from Cobham SATCOM (if available).

To access the Internet from a connected computer or wireless device, do as follows:

1. On the connected device, open your Internet browser.
2. Enter the IP address of your SAILOR Fleet One terminal. The default IP address is 192.168.0.1.
3. The built-in web interface of your SAILOR Fleet One terminal opens. With the web interface you can set up and control the SAILOR Fleet One and see status information.
4. At the top of the page, click the button **Start data connection**.

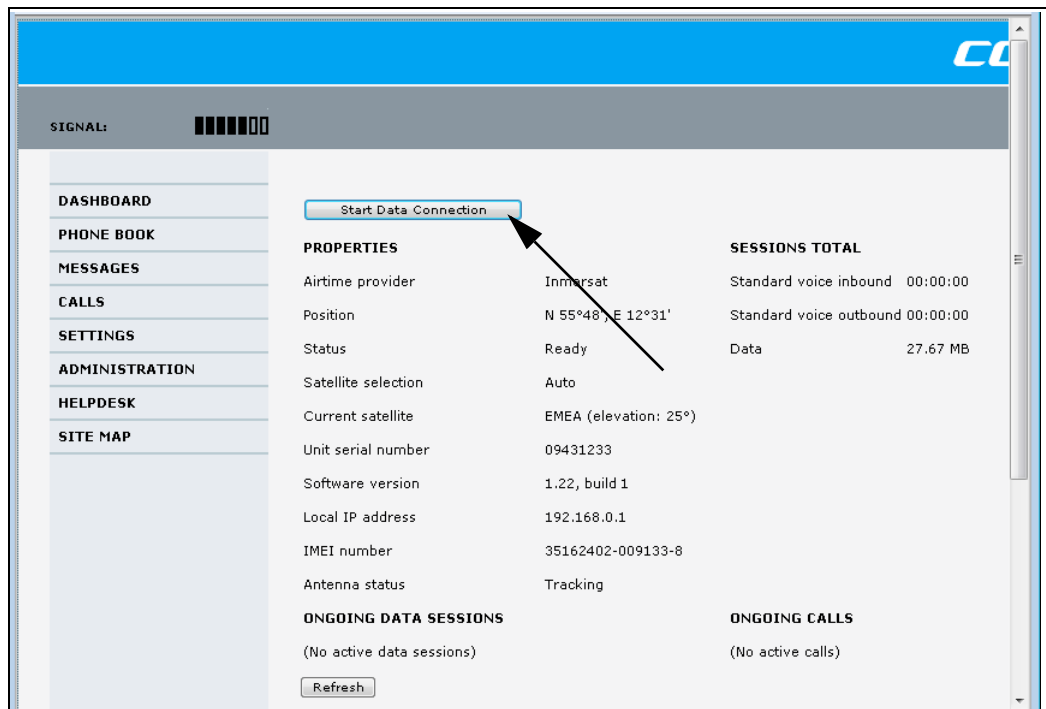

You should now have access to the Internet.

Note If you want the terminal to automatically start a data connection on startup, you can set it up in the web interface. See *Set up the data connection* on page 67. Be aware of automatic updates on your connected device - the updates are made over the satellite network, which will add to your airtime bill.

Operation

This chapter describes the options for making calls and data connections using the SAILOR Fleet One. It has the following sections:

- *Phone calls*
- *Data connection*
- *The built-in web interface*
- *Dashboard*
- *Phone book*
- *Call log*
- *SMS messages*
- *SIM PIN*

Phone calls

Connection options

You can choose from the following options for making phone calls with your SAILOR Fleet One:

- Using a smartphone and an external WLAN access point connected to the LAN interface. For connection and configuration, see *Connect a smartphone* on page 39.
- Using an analog phone connected to the Phone interface.
- Using an IP handset connected to the LAN interface. For connection and configuration, see *Connect an IP handset* on page 41.

To make or receive a phone call

To make a call from the SAILOR Fleet One

You have different options for making a call:

- **Short Dial.** If the number is in the phone book of the terminal, you can use the Short Dial number, which is found in the first column of the phone book in the web interface. See *Short dial* on page 58.
Dial **00 <Short Dial>** followed by **#** or off-hook key.
Example: To call entry number 4 in the phone book, dial **004** followed by **#** or off-hook key.
- **Manual Dial.** To make a call, dial **00 <country code> <phone number>** followed by **#** or off-hook key.
Example: To call Cobham SATCOM in Denmark (the number +45 39558800) from an analog phone, dial **00 45 39558800 #**
- **Call from phone book or call log** (only IP Handset from Cobham SATCOM).
 - Enter the phone book of the IP Handset, scroll to the wanted number and press the off-hook key, or
 - press the off-hook key from the main screen to display the latest calls in the call log. Then scroll to the wanted number and press the off-hook key again.
Note that this is the call log of the IP Handset, not of the terminal.

If there was an error establishing the connection, refer to the *Troubleshooting guide* on page 96.

If you have the IP Handset from Cobham SATCOM, the handset may show an error message.

Depending on the type of error, the web interface may also show an error message. See *Event list or Event log* on page 101.

Call log

Information of outgoing calls, received calls and missed calls is stored in the call log of the terminal. You can see the call log in the web interface under **CALLS**. For further information, see *To see the Call log* on page 59.

To make a call to the SAILOR Fleet One

To make a call to a phone connected to the terminal, dial

+ <SAILOR Fleet One number>

- **+** is the international call prefix¹ used in front of the country code for international calls.
- **SAILOR Fleet One number.** The first part of the number is always 870, which is the “country code” for the BGAN system. If the SAILOR Fleet One numbers are listed in the web interface, you can look them up as follows:
Connect a computer, access the web interface and select **PHONE BOOK > Mobile numbers**. For further information, see *Phone number of the SAILOR Fleet One* on page 58.

If the SAILOR Fleet One numbers are not available in the web interface, refer to the documents included with your airtime subscription.

To make local phone calls

You can make local calls between various phones connected to the terminal.

Local phone numbers always start with 0.

For an overview of the numbers assigned to each type of interface, see *Local numbers and special-purpose numbers* in the next section.

To make a local call, dial **<local number>** followed by off-hook key (from IP handset or smartphone) or **#** (from an analog phone).

Example: To call a smartphone assigned the number 0502 and connected via a WLAN access point to the LAN interface of the SAILOR Fleet One,
dial: **0502**

1. The plus sign indicates the code required to dial out of one's country code area, such as 00 in most of Europe, 011 in the United States, and other short codes in other parts of the world.

Dialling functions

Local numbers and special-purpose numbers

There are a number of dialling functions available in the terminal. The following list shows the allocated special-purpose numbers for the terminal.

Number	Function
0 * followed by # or off-hook key.	Redial last called number on this interface.
00 * followed by # or off-hook key.	Redial last answered call on this interface. Note: If the last answered number is unlisted, you are not allowed to dial back.
00 followed by one of the numbers 1-199 and # or off-hook key.	Short dial phone numbers in phone book.
0301 followed by # or off-hook key.	Local call to analog phone.
0500 followed by # or off-hook key	Local call broadcast to all IP handsets.
0 followed by one of the numbers 501-504 and # or off-hook key.	Local call to IP handset (or smartphone connected through a WLAN access point)

Dialling prefixes

Apart from the numbers above, the terminal uses the following dialling prefixes:

- **#31#** before the phone number will hide the caller's phone number to the recipient.
- ***31#** before the phone number will show the caller's phone number to the recipient where it would otherwise be hidden, e.g. because the number is an ex-directory number.
- For analog 2-wire telephones, use the **R** key during a call to get access to a supplementary services function (such as Call hold and Call transfer).

Data connection

Data connection types

There are different types of data connections from/to the SAILOR Fleet One:

- A user data connection for connecting your computer or other device to the Internet.
- A connection for tracking your SAILOR Fleet One, that is for sending distance reports or interval reports from the SAILOR Fleet One to a tracking server. See *Track the SAILOR Fleet One* on page 88.
- Two external data connections for use with 3rd party external equipment such as devices for fishery reporting etc. See *External data connections* on page 86.

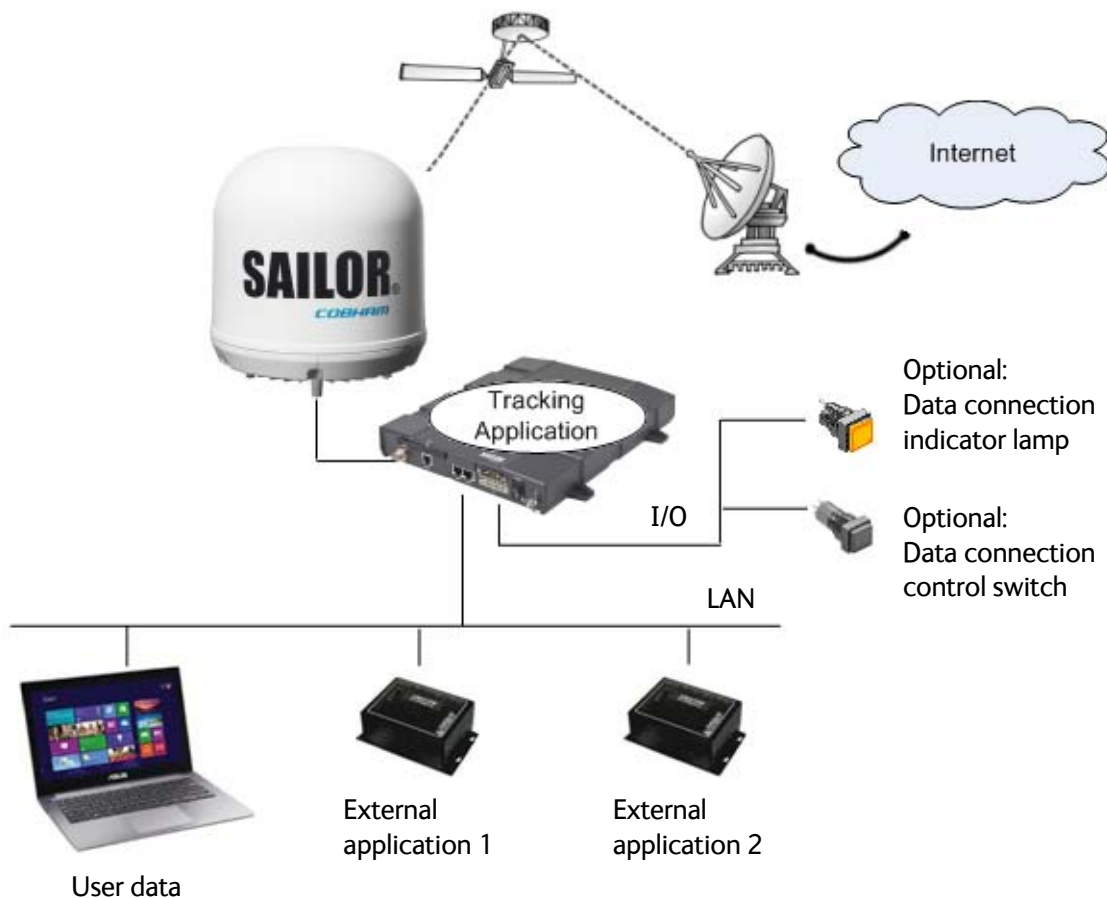

The data connections can be enabled/disabled using a switch connected to the I/O interface (see *To connect the data connection switch* on page 32) or individually from the web interface.

Physical connection options

You can choose from the following options for connecting a computer to your SAILOR Fleet One:

- Using an external WLAN access point connected to the LAN interface of the SAILOR Fleet One terminal. For connection and configuration, see the documentation for your WLAN access point.
- Using an Ethernet cable to connect directly to the SAILOR Fleet One terminal.

See also *LAN interface* on page 26.

To access the Internet

To access the Internet over the BGAN satellite network, you must first start a data connection on your SAILOR Fleet One. Do as follows:

1. On the connected device, open your Internet browser.
2. Enter the IP address of your SAILOR Fleet One terminal. The default IP address is 192.168.0.1.
3. The built-in web interface of your SAILOR Fleet One terminal opens. With the web interface you can set up and control the SAILOR Fleet One and see status.
4. At the top of the page, click the button **Start data connection**.

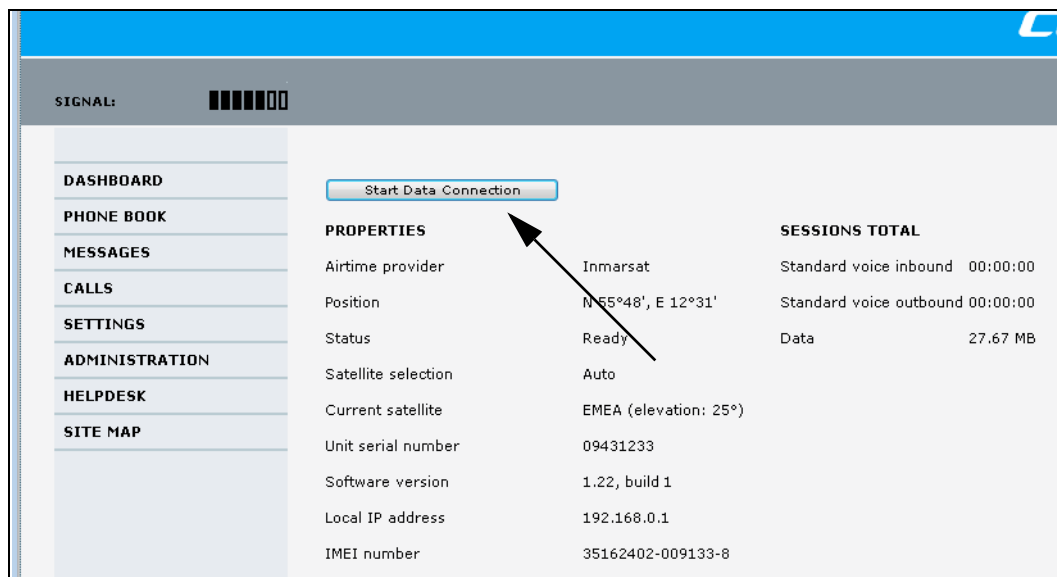

You should now have access to the Internet.

Note

Using the web interface you can set up the terminal to automatically start a data connection at startup. *Set up the data connection* on page 67

You can also connect a switch for disabling/enabling data connection. See *To connect the data connection status kit (optional)* on page 32.

The built-in web interface

The SAILOR Fleet One terminal has a built-in web interface, which is used for operating and configuring the SAILOR Fleet One system.

Note

The Proxy server settings must be disabled in your browser before accessing the web interface. Most browsers support disabling of the Proxy server settings for one specific IP address, so you can disable Proxy server settings for the web interface only, if you wish. Consult your browser help for information.

To access and navigate the web interface

To access the web interface

To access the web interface, do as follows:

1. Connect your computer to the terminal.
2. Start up the terminal.
For details, see *Start up the SAILOR Fleet One* on page 37.
3. Open your browser and enter **http://ut.bgan** or the IP address of the terminal in the address bar.

If your connected computer is set up to obtain a DNS server address automatically, this name is translated into the local IP address of the terminal. The default IP address of the terminal is **http://192.168.0.1**.

The web interface opens with the Dashboard, or, if the SAILOR Fleet One terminal is waiting for a PIN, it prompts you to enter the PIN (see *SIM PIN* on page 63.)

Overview of the web interface

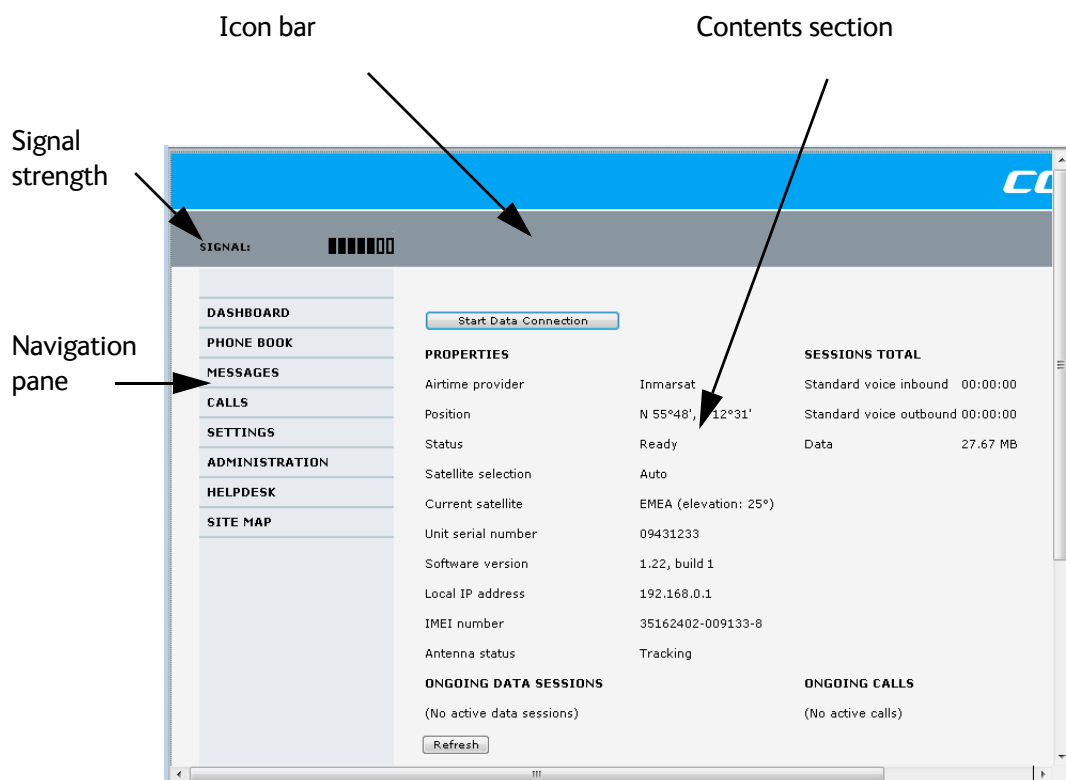

Below is an overview of the web interface.



- The navigation pane holds the main menu. Clicking an item in the menu opens a submenu in the navigation pane or a new page in the contents section.
- The signal strength of the satellite signal is shown graphically.
- The icon bar shows icons for new SMS messages and for active events, when relevant. For explanations of the icons, see the next section, *Icons in the icon bar*.
- The contents section shows the page selected in the navigation pane. This section is for seeing or changing settings or for performing actions.

Icons in the icon bar:

The following icons may appear in the icon bar in the web interface:

Icon	Explanation
	A new SMS message has arrived. Click the icon to see new messages. For further information, see <i>To see new SMS messages</i> on page 60
	An event is active. Click the icon to see a list of active events. For explanations of the event messages, see <i>List of events</i> on page 101. Note that this icon will remain in the icon bar as long as the event is still active

To navigate the web interface

- **To expand a menu**, click the menu in the navigation pane.
- **To access status and settings**, click the relevant subject in the navigation pane or click the relevant icon in the icon bar. The status or settings are displayed in the contents section.
- **To see the site map**, click **SITE MAP** in the navigation pane. The site map lists all topics and submenus. Click on items in the site map to go directly to the relevant location.

To change the language in the web interface

The default language of the web interface is English. You can change the language to French, German, Russian, Spanish, Mandarin (Chinese) or Japanese.

To change the language, do as follows:

1. Select **SETTINGS > Language**.
2. Select a language from the list.
3. Click **Apply**.



The screenshot shows a dialog box titled "LANGUAGE" with a light blue background. It contains a list of radio buttons for selecting a language: English (selected), Français, Deutsch, Русский, Español, 中文, and 日本語. At the bottom of the dialog, there are two buttons: "Apply" and "Cancel".

Dashboard

The Dashboard is used for control and inspection of ongoing communication and for seeing properties and status of the terminal and antenna.

For information on how to start or stop your data sessions from the Dashboard, see *Connect to the Internet* on page 44.

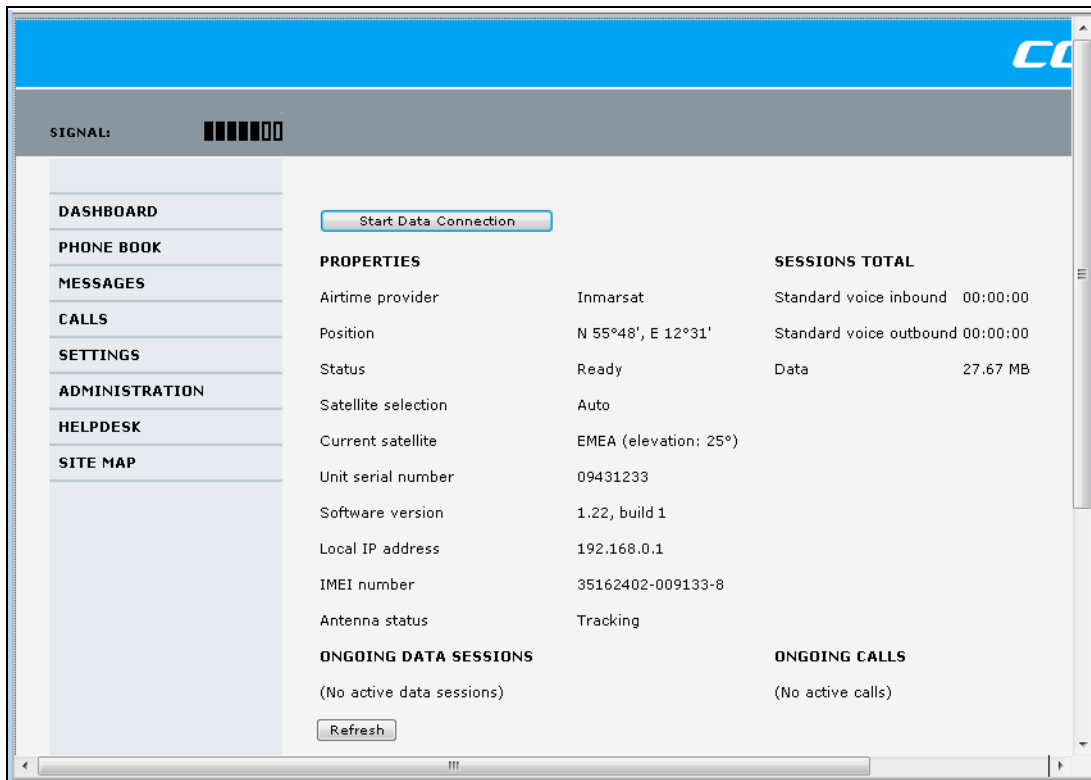

Properties

The **PROPERTIES** section of the **DASHBOARD** shows the following information:

- **Airtime provider.** The name of your airtime provider.
- **Position.** The position of your SAILOR Fleet One System. If the terminal has not yet acquired the position, this field shows **Acquiring**. See also *Positioning system* on page 91.
- **Status.** The status of the SAILOR Fleet One System. The status can be one of the following:

Displayed text	Meaning
Scanning	The terminal has instructed the antenna to scan for a BGAN signal. (The antenna status will show "Sky scan")
Searching	The antenna has found a BGAN signal and the terminal is searching for a BGAN network in order to perform a registration. (The antenna status will show "Tracking")
Registering	The terminal is trying to register with the Satellite Access Station (SAS).

Displayed text	Meaning
Ready	The terminal has registered and connected to the SAS and is ready to accept a service request (a call or a data session).
Data active	The terminal has established a call or a data session through the BGAN network.
No position fix	The GNSS receiver has not yet achieved position fix. It may take some time to achieve position fix depending on a number of conditions. First of all, the antenna should have an unblocked view to as much of the sky as possible. The terminal will not be able to register with the SAS without a position fix.
Not registered	The terminal has not been able to register with the BGAN network

- **Satellite selection.** The satellite selected for logon. For further information, see *Select a preferred satellite* on page 73.
- **Current satellite.** The satellite to which the system is currently logged on.
- **Unit serial number.** The serial number of the terminal.
- **Software version.** The version of the software embedded in the terminal.
- **Local IP address.** The local IP address of the terminal. This is the IP address used to access the terminal from a device connected to the terminal.
- **IMEI number.** The IMEI number (International Mobile Equipment Identity) of the terminal. This is a unique number that identifies your terminal.
- **Antenna status.** The status of the antenna.
The antenna status can be:

Displayed text	Meaning
Sky scan	The antenna is searching for the BGAN signal.
Tracking	The antenna has found and locked to the BGAN signal. The antenna is now tracking the BGAN signal.
No antenna	No known antenna is detected by the terminal.

To see information on calls and data connections

The following sections in the Dashboard show information on calls and data sessions.

Note The counters for calls and data sessions are only intended as a guide and cannot be used for direct comparison with your airtime bill.

- **ONGOING CALLS** is a list of calls that are currently active. The list shows the call type and the time connected for each call.
- **ONGOING DATA SESSIONS** is a list of data connections that are currently active, including the external IP address that is assigned to each connection.
- **SESSIONS TOTAL** lists the totals for each connection. The list shows the time connected (hh:mm:ss) for voice and MB transferred for data.

The counters show totals for connections since the counters were last cleared. For information on how to clear the counters, see *Log handling* on page 80.

Note If power to the terminal is interrupted unintentionally, the totals may be slightly inaccurate at next startup.

Phone book

In the phone book you can:

- Look up phone numbers
- Look up short dial numbers for easy dialling from a handset
- Change, delete or add new names and phone numbers.

Note

If you are using an IP Handset from Cobham SATCOM with the terminal, the contacts from this terminal phone book are included (read only) in your handset phone book.

To access the phone book

To access the phone book, select **PHONE BOOK** from the left navigation pane.

To sort the phone book, click the title of the column you wish to sort by. For example, to sort by the names in the phone book alphabetically, click on **Name** in the top row of the phone book.

The phone book holds 199 entries divided into subpages. To select the subpages you want, click the relevant link at the bottom of the page.

Entry	Name	Number	Actions
1	Cobham Satcom DK	004539558800	New
2			New
3			New
4			New
5			New
6			New
7			New
8			New
9			New
10			New
11			New
12			New
13			New
14			New
15			New
16			New
17			New
18			New
19			New
20			New

[Delete all entries in phone book](#)

1 2 3 4 5 6 7 8 9 10

Short dial

The entry number in the phone book is the Short dial number. When making a call from the terminal you can use this number instead of dialling the entire phone number.

Dial **00 <short dial>** followed by **#** or off-hook key.

Example:To call the third entry in the phone book from an analog phone, take the phone off hook and dial **003 #**.

To edit the phone book

- To add a new contact:
Click **New** in the right column, type in the name and phone number and click **Save entry**.
- To change the details for a contact:
Click **Edit** next to the contact you want to edit, change the name or number as needed and click **Save entry**.
- To delete a contact:
Click **Delete** next to the contact you want to delete.
- To delete all contacts in the phone book:
At the bottom of the page, click **Delete all entries in phone book**.

Phone number of the SAILOR Fleet One

Note

The phone number of your SAILOR Fleet One is not listed at delivery. The user must enter the number received from the airtime provider.

- To see the phone number, select **PHONE BOOK > Mobile numbers** from the left navigation pane.
- To enter or edit the phone number, click **Edit** at the bottom of the page, type in the number received from your airtime provider and click **OK**.
The number is now stored in the SAILOR Fleet One terminal for future reference.

Call log

Note

If power to the system is interrupted, the information on the currently ongoing calls (connection time) and data sessions (transferred data) cannot be saved. This could mean that the airtime and bandwidth usage registered in the Call log will be inaccurate and there is a risk of being charged for more airtime than registered in the web interface.

To use the Call log, select **CALLS** from the left navigation pane.

The CALLS page shows information on total usage for phone calls (time connected).

DASHBOARD	TOTAL USAGE
PHONE BOOK	Standard voice: 00:00:00
MESSAGES	
CALLS	Export call log to file
Outgoing calls	
Received calls	
Missed calls	
Data sessions	
SETTINGS	

To export the Call log

You can export the Call log file and save it on your computer for archiving, surveillance or other tracking purposes. The call log holds information on calls and data sessions since the call log was last cleared. For details how to see the Call log, see the next section.

To export the entire call log to a file, click the link **Export call log to file**, browse to the location where you want to save the log and click **OK**.

To see the Call log

To see information on outgoing, received or missed calls or data sessions, select one of the following lists from the left navigation pane in the CALLS page:

- **Outgoing calls** shows the start time, receiving end phone number, duration, type and estimated charge of each outgoing call.
- **Received calls** shows the start time, calling phone number, duration and type of each incoming call.
- **Missed calls** shows the start time, calling phone number and type of each incoming call that was not received.
- **Data sessions** shows the start time, bytes in, bytes out and estimated charge of each data connection.

Date and time is the international UTC time, received from the satellite.

SMS messages

To see new SMS messages

When a new message has arrived, the icon bar at the top of the web interface shows an unopened envelope. Click the envelope to see the new message(s) or click **MESSAGES** from the left navigation pane. Click a message to read it.

Note When you have received 100 messages, you must delete some of them in order to free space for new messages. Otherwise, the new messages are rejected.

From the MESSAGES page you can **Archive**, **Reply** or **Forward** messages. **Archive** moves the message to the Inbox.

To archive all new messages, click **Move all new messages to Inbox**.

Note The Inbox does not contain new messages, but only messages that you have archived from the MESSAGES page.

To send an SMS message

Do as follows

1. Click **MESSAGES** from the left navigation pane. This page contains new incoming messages.
2. In the left navigation pane, click **Write message**.

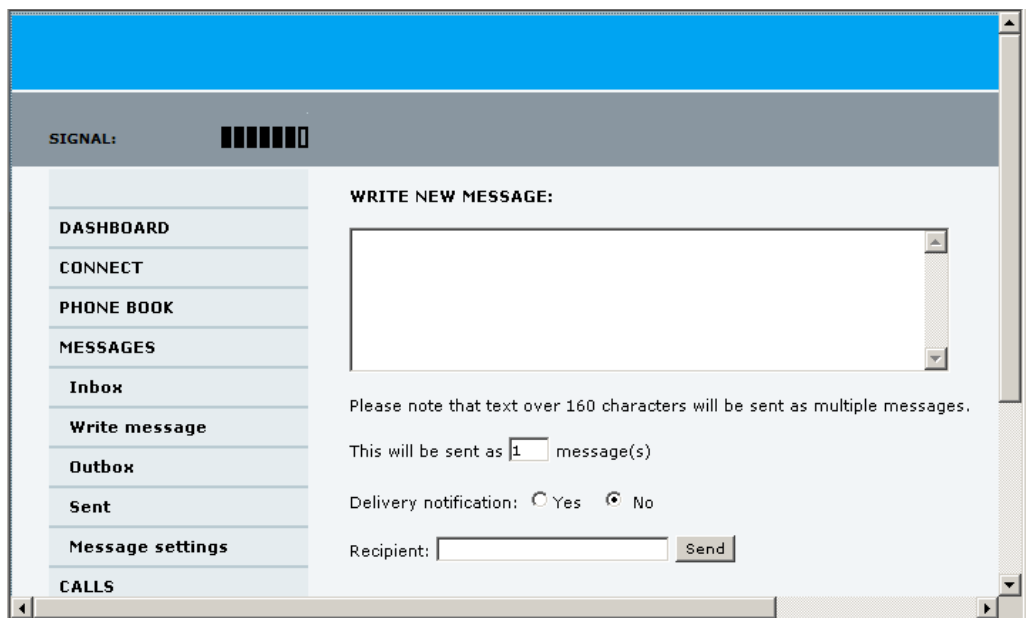

The screenshot shows a web interface for sending an SMS message. At the top, there is a blue header bar. Below it, a grey bar displays 'SIGNAL:' followed by a signal strength indicator consisting of seven vertical bars of varying heights. The main content area is divided into two sections. On the left is a vertical navigation pane with a light blue background, containing the following menu items: DASHBOARD, CONNECT, PHONE BOOK, MESSAGES, Inbox, Write message (highlighted in bold), Outbox, Sent, Message settings, and CALLS. The right section is titled 'WRITE NEW MESSAGE:' and contains a large text input field. Below the input field, there is a note: 'Please note that text over 160 characters will be sent as multiple messages.' This is followed by a label 'This will be sent as' and a small input field containing the number '1', followed by the text 'message(s)'. Below that is a 'Delivery notification:' label with two radio buttons: 'Yes' (unselected) and 'No' (selected). At the bottom of this section is a 'Recipient:' label followed by a text input field and a 'Send' button.

3. Type in the message in the **Write new message** field.
If the message text is too long for one SMS, the message is sent as two or more SMS messages. The field below the message field shows the number of SMS messages used to send the message.
4. Type in the phone number in the **Recipient** field.
Remember **00** and **country code** (e.g. **00 45** for Denmark or **00 1** for USA).
5. Select whether or not you want **Delivery notification** for this SMS message.
If you click Yes, the Status column in the Sent folder will show the status of your message when it has been sent.
You can set up delivery notification generally for all SMS messages. This setting is used by default when you send a message. For further information, see Configuring message settings on page 63.
6. Click **Send**.
The message is now sent and moved to the Sent folder.

To send an SMS message to the SAILOR Fleet One

To send an SMS to the SAILOR Fleet One, dial + <**SAILOR Fleet One phone number**>

Inbox, Outbox and Sent messages

- The **Inbox** contains incoming messages that have been read and moved from the MESSAGES page (see the previous page).
- The **Outbox** contains messages that have not been sent, e.g. because the terminal was not online when you attempted to send the messages.
- The **Sent** page contains messages that have been sent.

To configure message settings

To set up the default message options

You can set up general options for your outgoing messages. These settings apply by default to all your outgoing messages. Note, however, that you can change the Delivery notification setting for an individual message. For further information, see *To send an SMS message* on page 60.

Do as follows:

1. Select **MESSAGES > Message settings** from the left navigation pane.



The screenshot shows a settings dialog box with the following fields and options:

SMS service center:	+870772001799	Edit
Voice mail number:	+870772001899	
Include message in reply:	<input type="radio"/> Yes	<input checked="" type="radio"/> No
Delivery notification:	<input type="radio"/> Yes	<input checked="" type="radio"/> No

At the bottom of the dialog are two buttons: **Apply** and **Cancel**.

2. If you want to include the original message when you reply, select **Yes** next to **Include message in reply**.
3. Select whether or not you want **Delivery notification** for SMS messages. If you click Yes, the Status column in the Sent folder will show the status of your message when it has been sent.
4. Click **Apply**.

SMS service center

The **SMS service center** number identifies the SMS service centre used when sending and receiving SMS messages. The SMS service centre number is stored on the SIM card.

Click **Edit** next to the number to change it. The SMS service centre number is supplied by your airtime provider.

Voice mail number

The Voice mail number is the number you call to hear your incoming voice mail.

Note The Voice mail number is only listed if it is available on the SIM card. Otherwise, refer to the information included with your airtime subscription.

SIM PIN

Do you need a SIM PIN?

Note You may not have to enter a SIM PIN to access the terminal. This depends on whether or not the use of a SIM PIN is enabled on your SIM card. The administrator can enable and disable the use of a SIM PIN. For details, see *To enable or disable the use of a PIN* on page 81.

If a computer is connected when you start up the terminal, you can access the web interface and enter the SIM PIN here.

To enter the SIM PIN

If your SIM card requires a PIN, and the PIN has not yet been entered, you must enter it. Until you have entered the PIN you can only upload software and see the DASHBOARD. Access to all other parts of the web interface and to the satellite network requires a PIN. You have the following options:

- Access the web interface and enter the PIN there.
- Use an analog phone connected to the terminal.
- Use an IP Handset from Cobham SATCOM

Note Using the web interface with an administrator user name and password you can change the PIN and enable or disable the use of a PIN. For further information, see *Configure the SIM PIN* on page 81

To enter the PIN using the web interface

To enter the PIN in the web interface, do as follows:

1. On a computer connected to the terminal, open your browser and enter **http://ut.bgan** or the **IP address of the terminal** in the address bar (default IP address: http://192.168.0.1).

If your SIM card uses a PIN and the PIN has not yet been entered, the web interface will open on the PIN page.

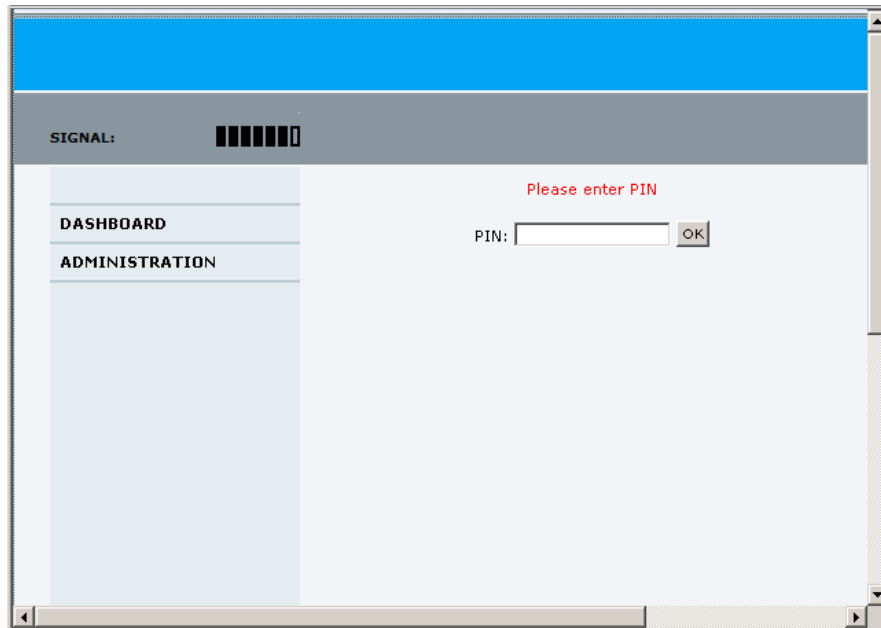

2. Type in the PIN and click **OK**.

When the PIN is accepted, the web interface opens the Dashboard and is ready for use. If the PIN is not accepted, see *Wrong PIN* on page 65.

To enter the PIN using an analog phone

With an analog phone connected to the terminal, do as follows:

1. Pick up the phone. When the terminal is waiting for a PIN, you will hear 2 beeps - pause - 2 beeps - etc.
2. Dial <PIN> followed by #.

When you hear a “busy” tone or a dialling tone, the PIN has been accepted and you can hang up or dial a number. If you do not hear a “busy” or dialling tone, you may have entered a wrong PIN. See *Wrong PIN* below.

To enter the PIN using the IP Handset from Cobham SATCOM

With an IP Handset connected to the terminal, do as follows:

1. From the handset display, select **Menu**.
2. Select **BGAN > Enter PIN**.

Note | The menu item “Enter PIN” is only available when the terminal is waiting for a PIN.

3. Enter the administrator user name and password for the terminal.
Default user name: admin and password: 1234.

4. Enter the PIN.

When the display shows the handset ready symbol  in the upper right corner, the handset is ready for making a call.

Wrong PIN

After having entered the user name and password for the terminal you have 3 attempts to enter the SIM PIN, before you are asked to enter the PUK (Pin Unblocking Key). The PUK is supplied with the SIM card for your terminal.

Enter the PUK followed by a new PIN of your own choice. The PIN must be from 4 to 8 digits long. If you enter a wrong PUK 10 times, the SIM card will no longer be functional, and you have to contact your airtime provider for a new SIM card.

Analog phone:

If, instead of the busy tone or dialling tone, you continue to hear 2 beeps - pause - 2 beeps - etc., it means the SIM PIN was not accepted. Check that you have the correct PIN and try again.

If a wrong PIN has been entered three times in the terminal, you will hear 3 beeps - pause - 3 beeps - etc. This means you have to enter the PUK (PIN Unblocking Key) provided with your SIM card.

After entering the PUK, you must enter a new PIN of your own choice (4 to 8 digits long).

Dial the following:

<PUK> * <New PIN> * <New PIN> #

Example: If the PUK is 87654321 and the new PIN is 1234, dial
87654321 * 1234 * 1234 #

Configuration

This chapter describes how to configure the SAILOR Fleet One. using the web interface. It has the following sections:

- *Set up the data connection*
- *Set up the interfaces*
- *Select a preferred satellite*
- *Set coverage restrictions (Geo-fencing)*
- *Log on as administrator*
- *Save or load a configuration*
- *Call charges*
- *Log handling*
- *Data limits*
- *Configure the SIM PIN*
- *Set up user permissions*
- *Restricted dialling*
- *External data connections*
- *Track the SAILOR Fleet One*
- *Antenna RF noise filter*
- *Positioning system*

Set up the data connection

To set up your data connection, do as follows:

1. From the **SETTINGS** page, select **Data connection**.



2. At **Data connection** select **Enabled** or **Disabled**.
 - If you select **Enabled**, you can start a user data connection, either automatically or manually (see next step).
 - If you select **Disabled**, you are not allowed to start user data connections on the BGAN network. However, you may still use the tracking function or an external data connection if enabled. See *External data connections* on page 86 or *Track the SAILOR Fleet One* on page 88.
3. At **Automatic activation**, select **Enabled** or **Disabled**.
 - If you select **Enabled**, the terminal automatically starts a data connection.
 - If you select **Disabled**, you must start a data connection manually from the Dashboard.
4. Select the source of the APN (Access Point Name).
There are two options for setting the APN. Unless you have special requirements, it is recommended to use the SIM default. You have the following options:
 - **SIM default**. The APN is taken from the SIM card.
 - **User defined**. Type in the APN. APNs are provided from the airtime provider.
5. If your APN uses a password, type in the user name and password provided from the airtime provider.

Note If you are going to use a static IP address from your SIM card, the user name and password are mandatory!

6. Click **Apply**.

Set up the interfaces

To configure the LAN interface

In the web interface you can set up the IP addressing between the terminal and devices connected to the terminal. The terminal has a built-in DHCP server, which is used to dynamically assign IP addresses to devices connected to the terminal.

You can also set up the local IP address used by the connected devices to access the terminal. The drawing below shows the default setup.

Local IP addresses (default setup)

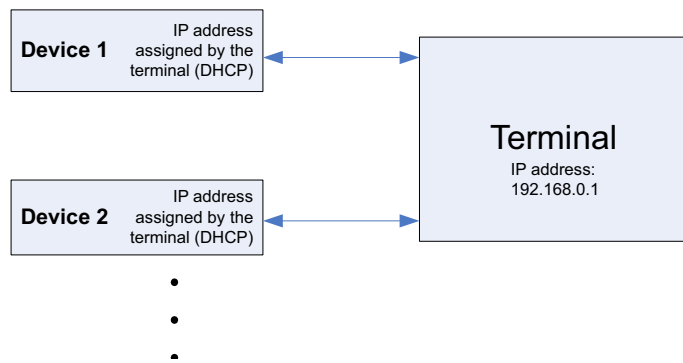

To change the LAN settings, do as follows:

1. Select **SETTINGS > LAN**.

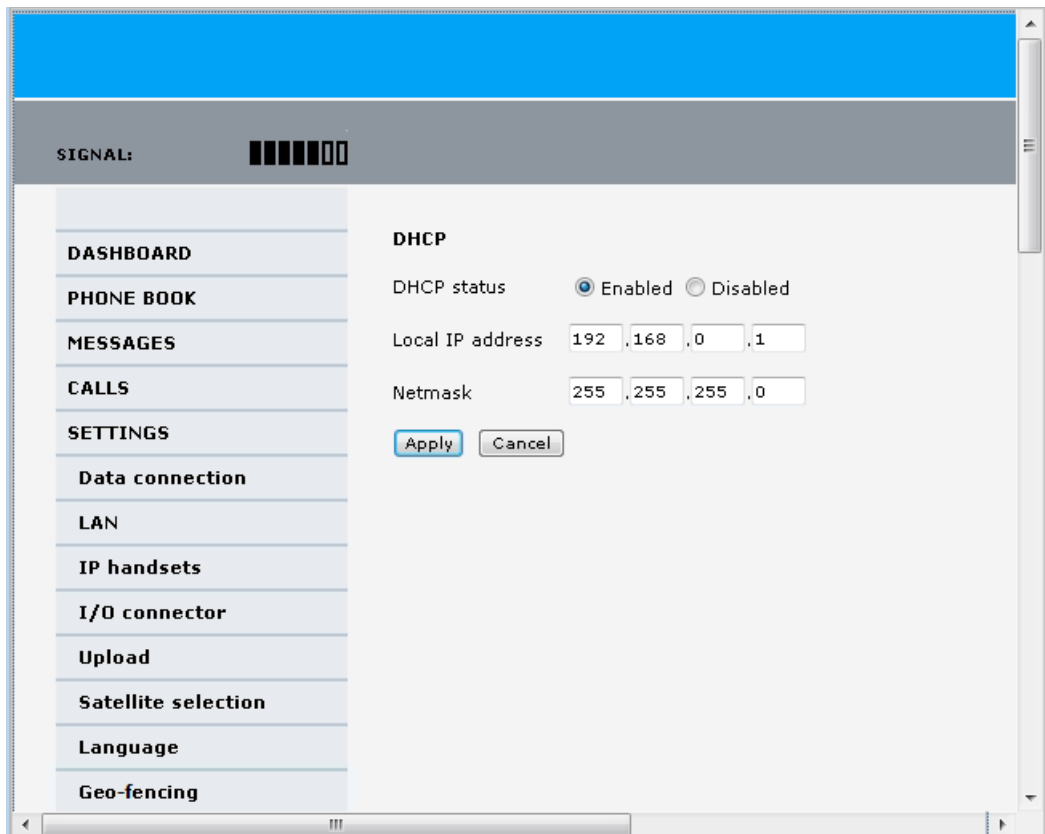

2. At DHCP status, select **Enabled** (recommended for most purposes), or **Disabled**.
 - If you select **Enabled**, the terminal assigns dynamic IP addresses to devices connected to the terminal.
 - If you select **Disabled**, you need to set up a static IP address in the connected device.

Note

A number of IP subnets cannot be used in connected devices because they are reserved for internal use in the terminal. See *List of reserved subnets* on page 112.

3. If you want to change the **Local IP address** and the **Netmask** of the terminal, type in the new address and netmask.

The Local IP address is the IP address of the terminal. It is used for accessing the web interface. By default, the address is 192.168.0.1 and the netmask is 255.255.255.0.
4. Click **Apply**.

To manage IP handsets and smartphones

You may connect your IP handsets directly to the LAN interfaces or use a PoE switch to connect more handsets. You may also connect a smartphone via a WLAN access point connected to the LAN interface. The SAILOR Fleet One terminal supports connection of up to 4 handsets or smartphones through the LAN interface.

Each handset or smartphone must have a unique local number in the range 0501 to 0504 as well as a unique password. By default, a handset number is automatically assigned when an IP Handset from Cobham SATCOM is connected. For other IP handsets, or if you want to change the password for the handset, see the next section *Connecting and configuring IP handsets or smartphones*.

Note

For IP Handsets from Cobham SATCOM: The IP Handset with the local number 0501 is the master IP Handset. This means you can start/stop data connections from the terminal with this IP Handset, if the function is allowed in the User permissions page. See *Set up user permissions* on page 83.

Connecting and configuring IP handsets or smartphones

Note An IP Handset from Cobham SATCOM that is connected to the LAN interface on the terminal is by default automatically registered in the terminal and assigned the first available local number and a password, which is the same number as the local number.

Do as follows:

1. Connect the IP handset to one of the LAN ports of the terminal, or connect your smartphone to a WLAN access point connected to the LAN interface.
If it is an IP Handset from Cobham SATCOM, the IP Handset starts up and is automatically registered and assigned the first available number.

2. In the web interface, select **SETTINGS > IP handsets**.

	Entry	Number	Handset password	Actions	Configure handset
DASHBOARD					
PHONE BOOK	1	0501	0501	Edit/Release	Reserved
MESSAGES	2	0502	0502	Edit	Unreserved
CALLS	3	0503	0503	Edit	Unreserved
SETTINGS	4	0504	0504	Edit	Unreserved
Data connection					
LAN					
IP handsets					
Call settings					
I/O connector					

3. If you want to change the password, click **Edit** next to the number you want to use.
4. Enter the password you want for your IP handset.

Note The IP Handset from Cobham SATCOM only supports numbers (no letters) in the password.

5. In the IP handset, enter the local number and the password you just entered in the web interface.

IP Handset from Cobham SATCOM	Other IP handsets or smartphone
<ol style="list-style-type: none"> 1. In the IP Handset, enter the menu system (select Menu) and select SIP to get the list of profiles. 2. Select the BGAN profile and select Options (left softkey). 3. Select Edit/View and change the user name and password. Note that the user name is also the local number for the IP Handset. 	Refer to the manufacturer documentation. See also <i>Configuration for making calls</i> on page 40.

The handset should now be connected to the SAILOR Fleet One.

The handset remains in the list after disconnecting. When the handset is connected again, it is automatically recognized and ready for use.

For IP Handsets from Cobham SATCOM: When the terminal and the handset have recognized each other, a **Configure** link appears next to the IP Handset in the list. Click this link to access the built-in web interface of the IP Handset. For further information, refer to the user manual for the IP Handset.

Enabling or disabling incoming calls to IP handsets or smartphones

In the Call settings page you can enable or disable incoming calls and see whether Restricted dialling is enabled for that number. Do as follows:

1. Select **SETTINGS > IP handsets > Call settings**.

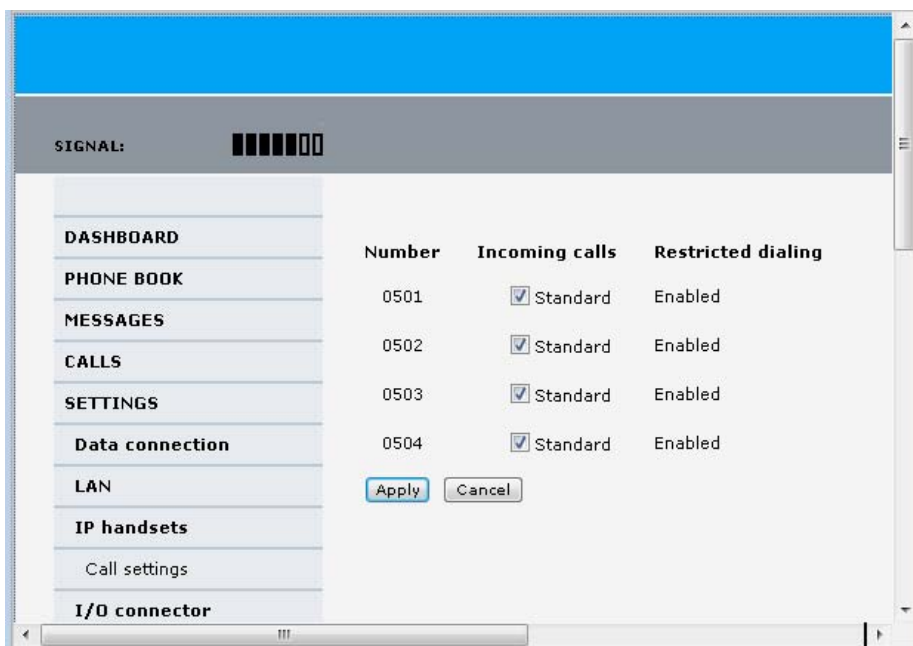

2. For each handset, select whether or not you want to receive incoming calls.
3. Click **Apply**.

This page also shows whether or not Restricted dialling is enabled. For details on Restricted dialling, see *Restricted dialling* on page 84.

To configure the I/O interface

The terminal has an I/O connector with 5 configurable inputs/outputs. For details on their functions and how to connect, see *I/O interface* on page 28.

To change the configuration of the I/O pins, do as follows:

1. Select **SETTINGS > I/O connector**.

Pin	I/O	Function	Enabled	Polarity
1	Output	Ringer	<input type="checkbox"/>	<input checked="" type="radio"/> Normally closed <input type="radio"/> Normally open
2	Output	Warning	<input type="checkbox"/>	<input checked="" type="radio"/> Normally closed <input type="radio"/> Normally open
3	Output	Data indication	<input checked="" type="checkbox"/>	<input type="radio"/> Normally closed <input checked="" type="radio"/> Normally open
4	Input	Data control	<input checked="" type="checkbox"/>	<input type="radio"/> Active high <input checked="" type="radio"/> Active low
5	Input	Ignition	<input type="checkbox"/>	<input checked="" type="radio"/> Active high <input type="radio"/> Active low

DELAYED SHUTDOWN

Delay (Minutes)

2. For each pin you want to use, select **Enabled**.
3. For each pin, select the function of the pin. Refer to *I/O pin functions* on page 29.
4. If you are using the Ignition function and you want the terminal to stay on for a few minutes after the Ignition is switched off, enter the number of minutes under **DELAYED SHUTDOWN**.
For further information on the Ignition function, see *Ignition system* on page 38.
5. Click **Apply**.

Select a preferred satellite

By default the terminal is set up to automatically find the most appropriate satellite to connect to (“Auto” mode). However, if you are located in an area with more than one BGAN satellite available, you can select the satellite you prefer to use when registering on the BGAN network.

Do as follows:

1. Select **SETTINGS > Satellite selection** from the left navigation pane.

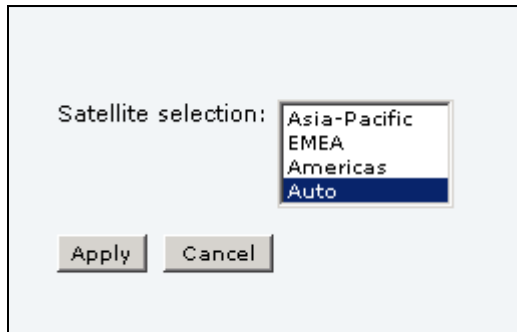

2. Select the satellite you prefer to use.
If you select **Auto** (the default setting) the SAILOR Fleet One system automatically uses the most appropriate satellite.

Important | If you have any ongoing calls or data sessions, they will be terminated when you click Apply!

3. Click **Apply**.
The SAILOR Fleet One terminates all ongoing connections and deregisters from the current satellite before registering on the new satellite.

Note | If you have selected one of the satellites, your SAILOR Fleet One will only try to register on the selected satellite. This means that if the antenna is outside the coverage area for that satellite, the SAILOR Fleet One will not be able to register with the BGAN network.

Set coverage restrictions (Geo-fencing)

You can set up the system to stop using the satellite network when the SAILOR Fleet One is outside a certain radius from a specific position.

Note

The system will close down all running connections without previous warning when the SAILOR Fleet One moves outside the selected area.

1. Select **SETTINGS > Geo-fencing** from the left navigation pane.

GEO-FENCING

Geo-fencing Enabled Disabled

Active	Center latitude	Center longitude	Radius [nmi]	Use current position
<input checked="" type="checkbox"/>	55N ° 47.62756348 ' °	12E ° 31.40562057 ' °	10	Autofill Entry
<input type="checkbox"/>	0N ° 0.00000000 ' °	0E ° 0.00000000 ' °	1	Autofill Entry
<input type="checkbox"/>	0N ° 0.00000000 ' °	0E ° 0.00000000 ' °	1	Autofill Entry
<input type="checkbox"/>	0N ° 0.00000000 ' °	0E ° 0.00000000 ' °	1	Autofill Entry
<input type="checkbox"/>	0N ° 0.00000000 ' °	0E ° 0.00000000 ' °	1	Autofill Entry
<input type="checkbox"/>	0N ° 0.00000000 ' °	0E ° 0.00000000 ' °	1	Autofill Entry
<input type="checkbox"/>	0N ° 0.00000000 ' °	0E ° 0.00000000 ' °	1	Autofill Entry
<input type="checkbox"/>	0N ° 0.00000000 ' °	0E ° 0.00000000 ' °	1	Autofill Entry
<input type="checkbox"/>	0N ° 0.00000000 ' °	0E ° 0.00000000 ' °	1	Autofill Entry
<input type="checkbox"/>	0N ° 0.00000000 ' °	0E ° 0.00000000 ' °	1	Autofill Entry

Apply Cancel

Disclaimer: Geo-Fencing is based on position and radius and has no relation to the actual airtime billing information. Thrane & Thrane cannot be held liable for any differences between entered Geo-fencing information and actual billing.

2. Select **Enabled** to enable Geo-fencing in general.
3. To use your current position as center, click **Autofill entry** in the right side.
4. Edit the center latitude and longitude and radius according to your needs.
5. Repeat the two previous steps if you want to enter more zones in which transmitting is allowed.
6. In the **Active** column select the zones you want to use for geo-fencing.
7. Click **Apply**.

Log on as administrator

The settings under Administration are password protected. Once you have entered the administrator user name and password you have access to all settings.

If you have not entered anything for 30 minutes, you are logged off automatically.

To log on

To log on, do as follows:

1. Select **ADMINISTRATION** from the left navigation pane.
2. Enter the Administration user name and password.
The default user name is **admin** and the default password is **1234**.

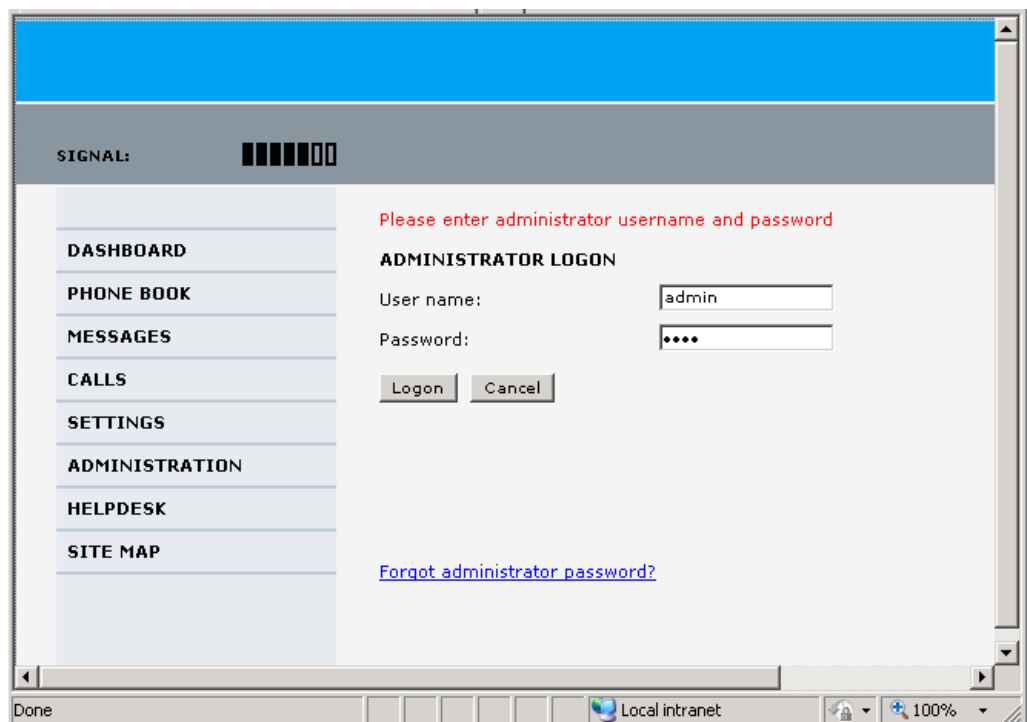

If you have forgotten the administrator password, you can reset the password by clicking the link at the bottom of the page. For further information, see the next section *To reset the administrator password* on page 76. The old user name and password will apply until you have finished the reset procedure.

3. Click **Logon**.

The ADMINISTRATION page is now updated to let you change the user name and password, Save/load a configuration or log off.
A number of subpages are now available under ADMINISTRATION.

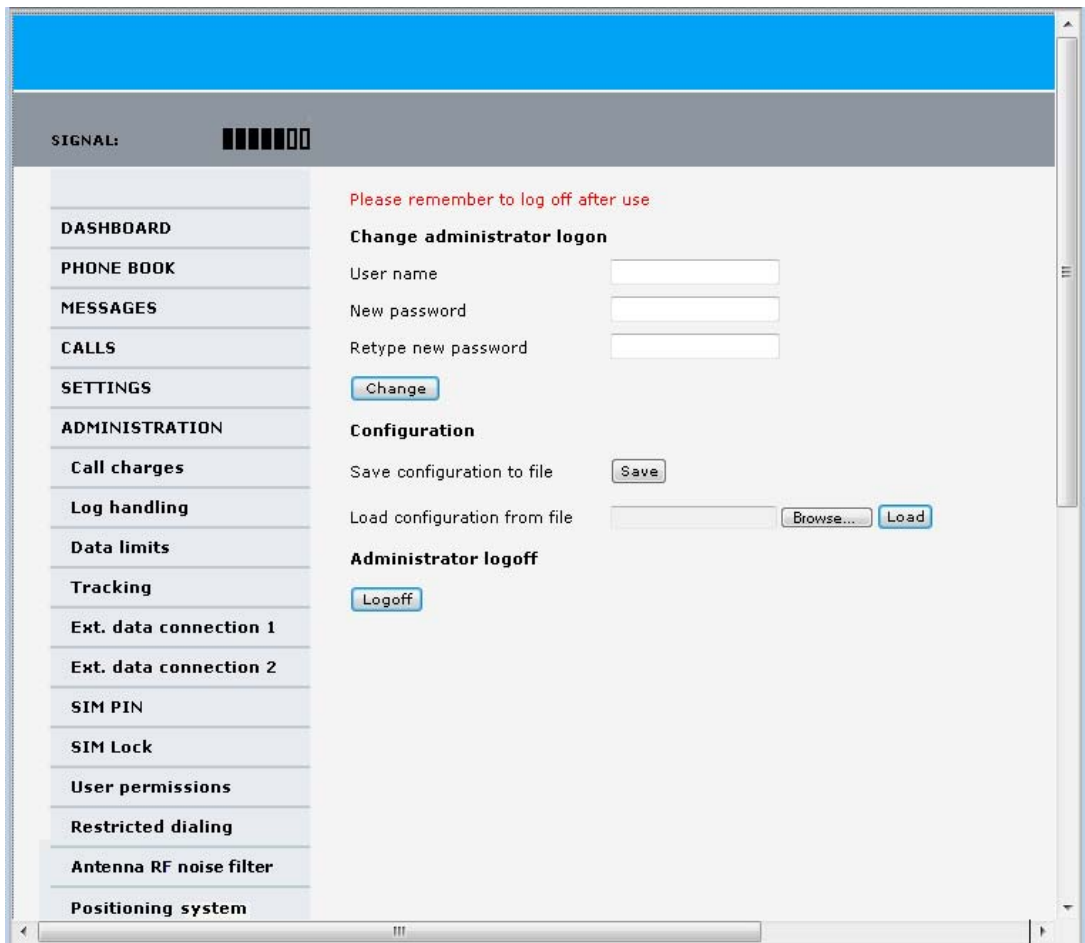

To reset the administrator password

If you have forgotten the administrator password, do as follows:

1. Contact your supplier for a reset code.
Please report the serial number and IMEI number of the terminal.
You can find the serial number and IMEI number in the Dashboard.
2. Click the link **Forgot administrator password?** at the bottom of the **ADMINISTRATOR LOGON** page (see the previous section).

RESET ADMINISTRATOR PASSWORD

Reset code:

3. Type in the reset code obtained from your supplier and click **Reset**.
4. Type in the user name **admin** and the default password 1234.
5. Click **Logon**.
6. For information on how to change the password, see the next section *To change the administrator password on page 77*.

To change the administrator password

To change the administrator password, do as follows:

1. After entering the administrator user name and password in the **ADMINISTRATION** page, locate the section **Change administrator logon**.

Please remember to log off after use

Change administrator logon

User name

New password

Retype new password

Configuration

Save configuration to file

Load configuration from file

Administrator logoff

2. Type in the existing user name.
3. Type in the new password and retype it on the next line.
4. Click **Change**.
At the next logon the new password is required.

Save or load a configuration

To save the current configuration to a file

If you need to reuse a configuration in another SAILOR Fleet One terminal, you can save your current configuration to a file, which can then be loaded into the other terminal.

Note

Configuration files can only be exchanged between terminals with the same software version!

To save your current configuration to a file, do as follows:

1. In the **ADMINISTRATION** page, under **Configuration**, click **Save**.
2. Accept the default destination file name or type in the destination file name and location.
3. Click **OK**.

The configuration is now saved to a file. This file is used to load the configuration into another terminal. See the next section.

To load a configuration from a file

To load a configuration from a file into the SAILOR Fleet One terminal, do as follows:

1. In the **ADMINISTRATION** page, under **Configuration**, click **Load**.
2. Click **Browse...** to browse to the file you want to import. Then click **Open**.
3. Click **Load**.

The new configuration is now loaded into your terminal.

Call charges

If you know the tariff for your subscribed services, you can enter these tariffs in the web interface and automatically calculate the charges for your calls and data sessions.

To enter the call tariffs, do as follows:

1. From the left navigation pane, select **ADMINISTRATION > Call Charges**.

The billing details from your Inmarsat Service Provider can be entered below.

Currency: (for display purposes only)

Standard voice: EUR per minute

Standard data: EUR per MegaByte (1000 kB)

Disclaimer: Please note that the estimates made on this basis are only indicative and Thrane & Thrane cannot be held liable for any differences between these and your actual bill. If you change the currency or the rates, these changes will also be applied to historical figures, so you may want to save the call log to a separate file to keep track of historical data.

2. Select the currency from the **Currency** drop-down list.
3. Enter the tariff for each of the services.
4. Click **Apply**.
5. The entered tariffs are used for estimating the charges for calls and data sessions. The estimated charge is listed for each call or data session in the call log. For further information, see *To see the Call log* on page 59.

Log handling

To clear the logs of the terminal and/or reset the counters for the time connected, do as follows:

1. From the left navigation pane in the **ADMINISTRATION** page, select **Log Handling**.

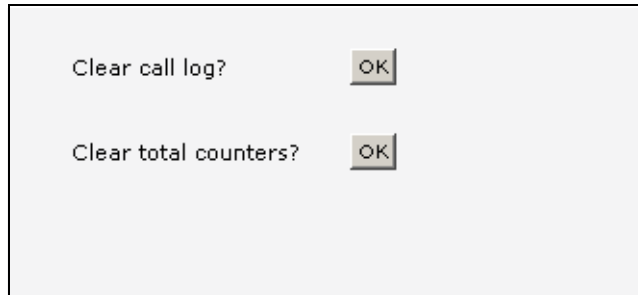

Clear call log?

Clear total counters?

2. To clear the Call log, click **OK** next to **Clear call log?**
3. To clear the total counters, click **OK** next to **Clear total counters?**.
This will reset the Time connected counters on the Calls page.

Data limits

You can set a limit for the use of data services with the SAILOR Fleet One system by specifying a maximum number of MB for the data connection.

Once the entered limit is reached, the connection is automatically stopped. This is recorded in the menu **CALLS** containing a call log in which you can see information on data sessions. To continue using the data services you must start a new connection by clicking the button **Start data connection** on the **Dashboard**.

Note | If you set a data limit for the data connection, automatic activation of the data connection is disabled.

To set data limits, do as follows:

1. From the left navigation pane in the **ADMINISTRATION** page, select **Data limits**.

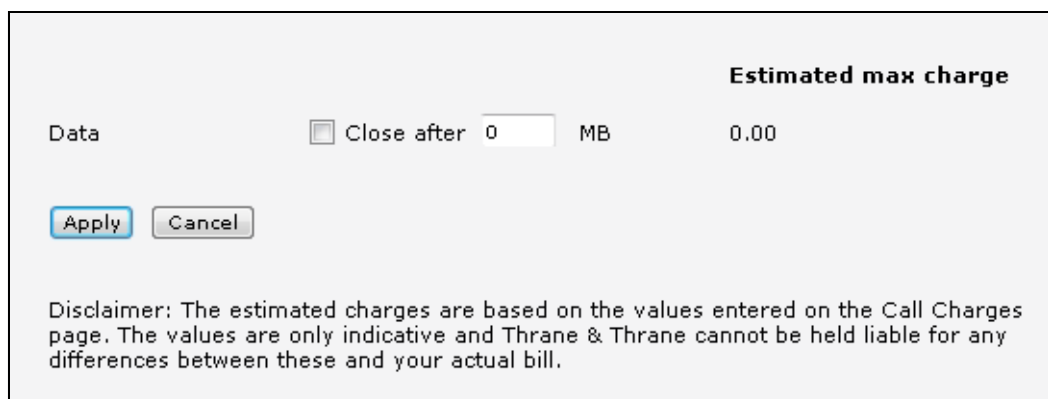

Data		Estimated max charge
	<input checked="" type="checkbox"/> Close after <input type="text" value="0"/> MB	0.00

Disclaimer: The estimated charges are based on the values entered on the Call Charges page. The values are only indicative and Thrane & Thrane cannot be held liable for any differences between these and your actual bill.

2. Select **Close after** to close automatically after a fixed amount of data.

3. Type in the number of mega bytes (MB) allowed.
4. Click **Apply** to save the settings.

If you have entered the call charges in the menu **Call charges**, the system automatically calculates and displays the maximum charges for your data sessions.

Note

Cobham SATCOM does not take responsibility for the correctness of the estimated charges. This calculation is only an estimate of the charge, based on the tariff entered by the user. The airtime provider may have different methods of calculating the charge.

Configure the SIM PIN

To enable or disable the use of a PIN

The administrator can choose whether or not to protect the terminal and SIM card with a SIM PIN. To enable or disable the use of a PIN, do as follows:

1. Select **ADMINISTRATION > SIM PIN**.

The screenshot shows a configuration window with two main sections. The first section, titled 'REQUIRE PIN', contains a label 'Require PIN on startup' followed by two radio buttons: 'Enabled' (which is selected) and 'Disabled'. Below this is a text input field labeled 'PIN'. At the bottom of this section are two buttons: 'Apply' and 'Cancel'. A horizontal line separates this section from the second section, titled 'CHANGE PIN'. This section contains three text input fields labeled 'Old PIN', 'New PIN', and 'Confirm new PIN'. At the bottom of this section are two buttons: 'Apply' and 'Cancel'.

2. Under **REQUIRE PIN** select **Enabled** or **Disabled**.
 - If you select **Disabled** you can access and use the terminal without entering a PIN.
 - If you select **Enabled** you must enter a PIN before you can change settings or make calls or data sessions.
3. Click **Apply**.

The new PIN settings will take effect at next power on.

To change the PIN

To change the PIN used to access the terminal, do as follows:

1. Select **ADMINISTRATION > SIM PIN**.

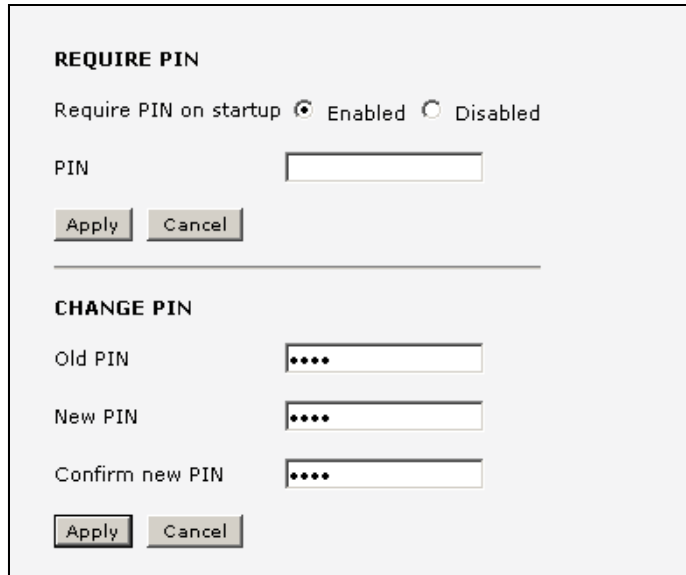

The screenshot shows a configuration dialog box with two sections: 'REQUIRE PIN' and 'CHANGE PIN'. The 'REQUIRE PIN' section has a radio button for 'Enabled' (selected) and 'Disabled'. Below it is a text input field for 'PIN' and 'Apply'/'Cancel' buttons. The 'CHANGE PIN' section has three masked text input fields for 'Old PIN', 'New PIN', and 'Confirm new PIN', followed by 'Apply'/'Cancel' buttons.

2. Under **CHANGE PIN** type in the **Old PIN**.
3. Type in the **New PIN** and retype it on the next line.
4. Click **Apply**.

The new PIN settings will take effect at next power on.

Set up user permissions

You can allow or deny users who are not administrators access to certain functions and make these pages read-only. This is useful if you want to protect the system against unintended changes. Study this screen thoroughly and decide to which areas of the system you want to give non-administrator users access. To set up the user permissions, do as follows:

1. From the left navigation pane, select **ADMINISTRATION > User permissions**.

ALLOW USERS TO:

Upload software	<input checked="" type="radio"/> Yes	<input type="radio"/> No
Edit phone book	<input checked="" type="radio"/> Yes	<input type="radio"/> No
Change phone settings	<input checked="" type="radio"/> Yes	<input type="radio"/> No
Change LAN settings	<input checked="" type="radio"/> Yes	<input type="radio"/> No
Change IP handset settings	<input checked="" type="radio"/> Yes	<input type="radio"/> No
Change I/O connector settings	<input checked="" type="radio"/> Yes	<input type="radio"/> No
Change general settings	<input checked="" type="radio"/> Yes	<input type="radio"/> No
Perform self test	<input checked="" type="radio"/> Yes	<input type="radio"/> No
Control connections from IP handset	<input checked="" type="radio"/> Yes	<input type="radio"/> No

ALLOW AT COMMANDS ON:

Changes to AT command permissions only take effect after reboot

LAN interface	<input checked="" type="radio"/> Yes	<input type="radio"/> No
---------------	--------------------------------------	--------------------------

Apply Cancel

2. For each item under **ALLOW USERS TO:**, select
 - **yes** to allow access or
 - **no** to block access to the settings.

Change general settings means change the selection of satellite.
Control connections from IP handsets means to start/stop data sessions using the IP Handset from Cobham SATCOM (master handset with the number 0501).
3. At **ALLOW AT COMMANDS ON:**, select
 - **yes** to allow the use of AT commands on the LAN interface, or
 - **no** to block the use of AT commands on the LAN interface.

Note | This setting does not take effect until the terminal is restarted.

AT commands are low-level commands used to control modems, in this case the SAILOR Fleet One terminal. They are typically used during service and maintenance or when troubleshooting the terminal.

4. Click **Apply**.

The settings to which access is denied are now greyed out for the non-administrator user.

Restricted dialling

RESTRICTED DIALING

Restricted dialing Enabled Disabled

Allowed numbers or masks

<input type="text" value="0045395588"/>	<input type="text"/>
<input type="text"/>	<input type="text"/>
<input type="text"/>	<input type="text"/>
<input type="text"/>	<input type="text"/>
<input type="text"/>	<input type="text"/>
<input type="text"/>	<input type="text"/>
<input type="text"/>	<input type="text"/>

Phonebook dialing

Limit outgoing calls to numbers in terminal phonebook Enabled Disabled

PHONE STATUS

0301 (Phone)	<input checked="" type="checkbox"/> Restrictions enabled
0501 (IP handset)	<input checked="" type="checkbox"/> Restrictions enabled
0502 (IP handset)	<input checked="" type="checkbox"/> Restrictions enabled
0503 (IP handset)	<input checked="" type="checkbox"/> Restrictions enabled
0504 (IP handset)	<input checked="" type="checkbox"/> Restrictions enabled

In order to manage the use of the system efficiently you can set up the terminal to limit all calls to allowed numbers or numbers in the phone book. This feature can be enabled for each connected handset separately. Each handset has its own local number.

To set up the terminal for restricted dialing, do as follows:

1. From the left navigation pane, select **ADMINISTRATION > Restricted dialing**.
2. Select whether restricted dialing should be **Enabled** or **Disabled**.
3. Type in the allowed numbers or masks in the entry fields.

The numbers or masks must be max. 32 digits and may start with +. No other special characters are allowed. A mask is the first part of a phone number, and it covers all numbers that start with that first part. See the example below.

Mask	Numbers accepted
00453955880	004539558800 to 004539558809
+45395588	004539558800 to 004539558899

4. Select whether outgoing calls should be limited to the numbers in the terminal phone book (Enabled) or not (Disabled).
5. Check which local numbers are available in your system. Then select for which local numbers you want to enable the restriction.
6. Click **Apply** to apply the new settings.

External data connections

You can connect external devices e.g. for fishery reporting. These external devices communicate with the SAILOR Fleet One using PPPoE or AT commands through the LAN interface.

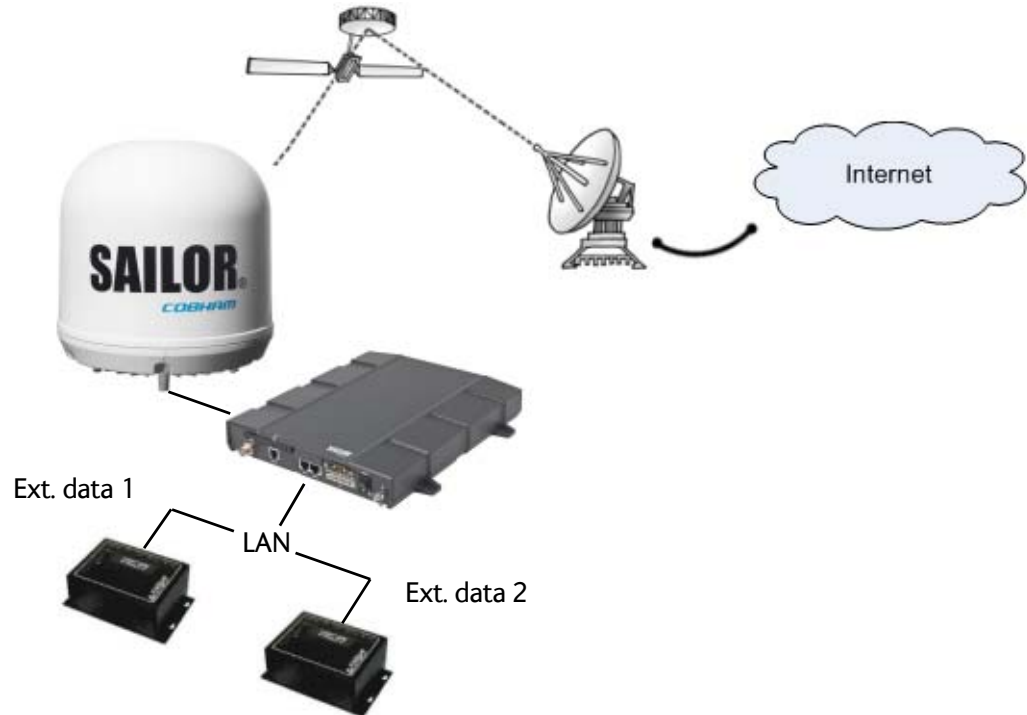

You can have two external data connections. To set up the data connections, do as follows (the procedure is the same for Ext. data connection 1 and 2):

1. From the left navigation pane, select **ADMINISTRATION > Ext. data connection 1**.

<ul style="list-style-type: none"> DASHBOARD PHONE BOOK MESSAGES CALLS SETTINGS ADMINISTRATION Call charges Log handling Data limits Tracking Ext. data connection 1 Ext. data connection 2 SIM PIN 	<p>EXTERNAL DATA CONNECTION 1</p> <p>Data connection <input type="radio"/> Enabled <input checked="" type="radio"/> Disabled</p> <p>I/O control <input type="radio"/> Yes <input checked="" type="radio"/> No</p> <p>Lock to MAC address <input type="text" value="00:00:00:00:00:00"/></p> <p><input type="button" value="Apply"/> <input type="button" value="Cancel"/></p>
---------------------------------------------------------------------------------------------------------------------------------------------------------------------------------------------------------------------------------------------------------------------------------------------------------------------------------------	--------------------------------------------------------------------------------------------------------------------------------------------------------------------------------------------------------------------------------------------------------------------------------------------------------------------------------------------------------------------------------------

2. Select **Enabled** to enable the use of this external data connection.
If you select **Disabled**, this data connection cannot be used.
3. If you have installed a data connection switch, select **Yes** or **No** next to **I/O control**.
 - Select **Yes** if you want this external data connection to follow the setting of the data control switch, that is when the data control switch disables data, this external data connection is also disabled.
 - Select **No** if you want this external data connection to be independent of the data control switch.

For details on the use of a data connection switch, see *To connect the data connection status kit (optional)* on page 32.
4. Type in the MAC address of the equipment used for the external data connection.
The data connection is now locked to this MAC address and cannot be used with any other equipment.
5. Click **Apply**.

Track the SAILOR Fleet One

The SAILOR Fleet One system can be used for tracking purposes. You can set up the terminal to report to a server at certain time intervals or after moving a specified distance.

To use the tracking feature you must either set up a tracking server or get a tracking solution from your service provider. The SAILOR Fleet One system must be set up to match this server. Once set up on both sides, the SAILOR Fleet One system will send position reports to the server as specified.

To set up tracking, do as follows:

1. Select **ADMINISTRATION > Tracking**.

TRACKING

I/O control Yes No

SERVER CONNECTION

Server IP address 0 ,0 ,0 ,0

Server port 7474

Client port 7475

Encryption key 00000000000000000000000000000000

Allow remote control Yes No

APN

SIM default

User defined bgan.inmarsat.com

User name

Password

POSITION REPORTS

Report type Compressed

Extended

ECEF

INTERVAL REPORT

Status Enabled Disabled

Report each 0 :30 (hh:mm)

DISTANCE REPORT

Status Enabled Disabled

When moved 0 meters

Max one report per 0 :0 (hh:mm)

2. If you have installed a data connection switch, select **Yes** or **No** next to **I/O control**.
 - Select **Yes** if you want the tracking function to follow the setting of the data control switch, that is when the data control switch disables data, tracking is also disabled.
 - Select **No** if you want the tracking function to be independent of the data control switch.

For details on the use of a data connection switch, see *To connect the data connection status kit (optional)* on page 32.
3. Type in the **Server IP address**, **Server port**, **Client port** and **Encryption key** for your server connection.
 - **IP address**. The IP address of the server that the SAILOR Fleet One will report to.
 - **Server port**. Port number on the server. Default number is **7474**.
 - **Client port**. Port number on the SAILOR Fleet One terminal. Default number is **7475**.
 - **Encryption key**. A supplied 128 bit key which must match on both the client and server side.
4. To allow remote control of the tracking settings from the tracking server, select **Yes at Allow remote control**.

This means the SAILOR Fleet One terminal will accept commands from the specified tracking server, for example to change reporting intervals or start/stop reporting.
5. Select the **APN** to use for Tracking. You have the following options:
 - **SIM default**. The APN is taken from the SIM card. This is the recommended option, unless you have special requirements.
 - **User defined**. Type in the APN. APNs are provided from the Airtime Provider.
6. Under **Position reports**, select the report type you want to use.
 - **Compressed**. Only latitude and longitude are reported.
 - **Extended**. Apart from latitude and longitude, heading and altitude are also included.
 - **ECEF**. The same information as Extended, but position and speed data are 3D (ECEF coordinates).
7. Under **Interval report**, select **Enabled** or **Disabled** and type in the interval between the reports.
8. Under **Distance report**, select **Enabled** or **Disabled** and type in the following:
 - **When moved**. Enter the distance the vessel should be moved before sending a report.
 - **Max one report per**. Enter the minimum time that should pass between two reports.

Example: The distance is set to 1000 m and the time is set to 15 minutes. The SAILOR Fleet One system has moved 1000 m since last report, but only 10 minutes have passed. A report will not be sent until the 15 minutes have passed.
9. Click **Apply**.

Antenna RF noise filter

The SAILOR Fleet One system has a built-in filter that makes it resilient to interference from terrestrial mobile systems that operate inside the Inmarsat band and that may be located near the coast.

Note

We recommend leaving this setting as is (Auto). By default, the filter is automatically activated when the SAILOR Fleet One system is subjected to interference.

To set up the Antenna RF noise filter, do as follows:

1. From the left navigation pane, select **ADMINISTRATION > Antenna RF noise filter**.

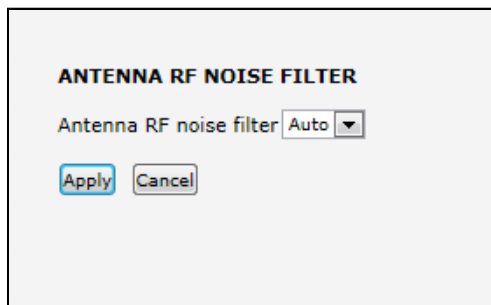

2. Select **Auto**, **On** or **Off**.
 - **Auto**. The filter is automatically activated when the SAILOR Fleet One is subjected to interference from terrestrial mobile systems.
 - **On**. The filter is always active.
 - **Off**. The filter is never active.
3. Click **Apply**.

Positioning system

The SAILOR Fleet One uses the GPS positioning system by default, but you can select between **GPS**, **Beidou**, **GPS and Beidou** and **GPS and GLONASS**.

1. From the left navigation pane, select **ADMINISTRATION > Positioning system**.

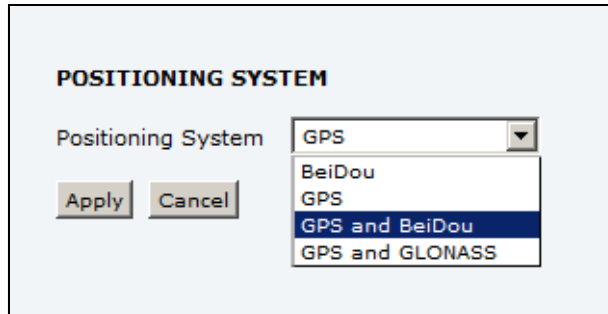

The screenshot shows a configuration window titled "POSITIONING SYSTEM". It features a label "Positioning System" next to a dropdown menu. The dropdown menu is open, showing four options: "GPS", "BeiDou", "GPS and BeiDou", and "GPS and GLONASS". The "GPS and BeiDou" option is currently selected and highlighted in blue. Below the dropdown menu are two buttons: "Apply" and "Cancel".

2. From the drop-down list, select the positioning system(s) you want to use.
3. Click **Apply**.

Note If you have selected the Beidou system and you move outside BeiDou coverage, you will eventually lose connection to the satellite network. The Position field in the Dashboard of the web interface will show "Acquiring".

Maintenance and troubleshooting

This chapter gives guidelines for troubleshooting and provides an overview of the different means of status signalling. It has the following sections:

- *Get support*
- *Update software*
- *Part numbers*
- *Troubleshooting guide*
- *Status signalling*
- *Generate a diagnostic report*
- *Event messages*
- *Reset button*
- *List of reserved subnets*
- *Extended status*
- *Antenna properties*
- *Self test*

Get support

If this manual does not provide the remedies to solve your problem, you may want to contact your Airtime Provider or your local distributor.

Lists of certified partners and distributors are available on www.cobham.com/SATCOM. Select **Service and Support** from the top menu bar and then **AVIATOR, EXPLORER, SAILOR Service and Support**. Then select one of the dealers or partners lists shown.

You can enter the contact details for your dealer or airtime provider in the Help desk in the web interface for future reference.

Update software

The next pages describe how to upload software from your computer to the terminal and how to download the latest software version from the Internet to your computer.

You can upload software from your computer to the terminal without entering the PIN. However, if your SIM card requires a PIN and the PIN is not entered, you must enter the Administration user name and password.

To upload software from your computer

To upload software from your computer to the terminal, do as follows:

1. Download the new software as described in the next section, or acquire the software from Cobham SATCOM and save it on your computer.
2. Open the web interface and do one of the following:
 - If the PIN has been accepted (or a PIN is not required), select **SETTINGS > Upload** from the left navigation pane.
 - If a PIN is required and the PIN has not been entered:
 - a. Select **ADMINISTRATION**
 - b. Enter the Administration PIN and password and click **Logon**.
The default user name is **admin** and the default password is **1234**.
 - c. Select **Upload** from the left navigation pane.

The UPLOAD page opens.

CHECK FOR SOFTWARE UPDATES

Current software version 1.21

Latest available Not checked...

File size

UPLOAD SOFTWARE TO TERMINAL

Disclaimer for Downloading and Uploading software:
Please be informed that downloading and installing software from the Thrane & Thrane web portal is at your own risk. Thrane & Thrane is not to be held liable for any possible damage with respect to downloading and installing software to your SAILOR Fleet One.

If you have problems or questions with respect to downloading software or uploading your terminal please be informed that you will have to contact the Thrane & Thrane distributor from where the terminal was purchased or contact your local Thrane & Thrane distributor.

Please be advised that you will not be able to contact Thrane & Thrane for end user support and that we always recommend that software upgrades are being carried out by official Thrane & Thrane distribution partners.

3. In the field **UPLOAD SOFTWARE TO TERMINAL**, click **Browse...**
4. Browse to the new software version and accept it.
5. Click the **Upload** button.
Note that the upload procedure takes a couple of minutes.

Note When upload is done, your terminal automatically restarts with the new software.

To download software from the Internet

Important The terminal uses your BGAN airtime subscription to download the new software from the Internet. Note that it can take several minutes to download the software.
If you don't want to use airtime you can acquire the software from Cobham SATCOM, save it on your computer and then connect the computer to the terminal.

To download the latest software from the Internet to the terminal, do as follows:

1. Make sure you have a connection to the Internet from your terminal.
2. Open the web interface and select **SETTINGS > Upload** from the left navigation pane.

CHECK FOR SOFTWARE UPDATES

Current software version	1.21
<input type="button" value="Check for updates"/>	
Latest available	Not checked...
File size	

UPLOAD SOFTWARE TO TERMINAL

Disclaimer for Downloading and Uploading software:
Please be informed that downloading and installing software from the Thrane & Thrane web portal is at your own risk. Thrane & Thrane is not to be held liable for any possible damage with respect to downloading and installing software to your SAILOR Fleet One.

If you have problems or questions with respect to downloading software or uploading your terminal please be informed that you will have to contact the Thrane & Thrane distributor from where the terminal was purchased or contact your local Thrane & Thrane distributor.

Please be advised that you will not be able to contact Thrane & Thrane for end user support and that we always recommend that software upgrades are being carried out by official Thrane & Thrane distribution partners.

3. Click **Check for updates**.
The terminal will now connect to the Internet through the BGAN network, using your airtime subscription. It may take a minute or two to obtain the new software version. When the new software version is found, the web interface shows the new software version and a link for downloading the software.
4. Click the link to download the new software to your computer.
After saving the software, follow the procedure in the previous section (*To upload software from your computer*) to upload the software from the computer to your terminal.

Part numbers

System units

SAILOR Fleet One system

Item	Part number
SAILOR Fleet One antenna	403050C-00581
SAILOR Fleet One terminal	403739A-00581

IP Handset, wired

Item	Part number
IP Handset, wired	403672A
IP Cradle, wired	403674A

Troubleshooting guide

The below table provides information on some of the problems that might occur, including possible causes and remedies to solve the problems.

Problem	Possible cause	Remedy
No signal or weak signal from the BGAN satellite.	The view to the satellite is blocked.	Make sure the antenna has a clear view in all directions. See the installation manual for details.
	The antenna cable is not properly connected.	Check that both ends of the cable are connected properly according to the guidelines in the Installation manual. Also check that no connectors are damaged.
	The system is set up to use one specific satellite, but the system is outside coverage from that satellite.	Enter the web interface. Select SETTINGS > Satellite selection . Select Auto and click Apply . The system will now search for the satellite with the strongest signal and attempt to connect.
Connection is closed down	You are outside coverage of either positioning system or the Fleet One service. Positioning system: If you have selected BeiDou (only), and you move outside coverage of BeiDou, your connection is closed down. Geo-fencing: If you have set up areas for Geo-fencing and you move outside those areas, your connection is closed down.	Positioning system: Select another positioning system or move back into the coverage area. See <i>Positioning system</i> on page 91. Geo-fencing: Disable Geo-fencing, set up a new area, or move back into the allowed area. See <i>Set coverage restrictions (Geo-fencing)</i> on page 74.
Connection to the Internet cannot be established.	Data connection may not be enabled.	Make sure that you have enabled data connection under SETTINGS > Data connection . If you have a data control switch installed, make sure it is in the “enabled” position. For details, see <i>To connect the data connection switch</i> on page 32.

Problem	Possible cause	Remedy
The web interface cannot be accessed.	The browser is configured to use a proxy server.	In your browser, under your Internet connection settings, select NOT to use a proxy server for your LAN.
	You have entered a wrong IP address.	Check the IP address and re-enter it. If you do not have the correct IP address, you can set the IP address temporarily to the default address (192.168.0.1) by pressing the Reset button. See <i>Reset button</i> on page 110.
	You are connected using VPN	Close your VPN connection.
A Phone connection cannot be established.	The cable is not properly connected.	Connect the cable.
	The cable type or connector type is not correct.	For information on the correct type of connector and cable, refer to <i>Phone interface</i> on page 25.
A LAN connection cannot be established.	The cable is not properly connected.	Connect the cable.
	The cable type or connector type is not correct.	For information on the correct type of connector and cable, refer to the installation manual.
	<p>The connected equipment is set up to use a static IP address and</p> <ol style="list-style-type: none"> 1. the IP address is reserved for internal use in the terminal, or 2. the terminal is set up to assign a dynamic IP address to the equipment. 	<p>Do one of the following:</p> <ol style="list-style-type: none"> 1. Change the IP address of the connected equipment to an IP address that is not reserved. See <i>List of reserved subnets</i> on page 112. 2. Set up the equipment to use a dynamic IP address, or disable DHCP in the terminal. See <i>To configure the LAN interface</i> on page 68.

Problem	Possible cause	Remedy
An IP handset connection cannot be established.	The cable is not properly connected.	Connect the cable.
	There is no power (PoE) in the LAN interface. The reason may be that there is not enough power to supply PoE for the LAN interface.	Check that the input voltage is within the specified range (10.5 - 32 V DC; 11.5 A - 4 A). Check that you do not have too many power-consuming devices connected. The maximum available output power on the LAN (PoE) interface is 32 W. If possible, disconnect other connected devices.
The administrator password does not work.	Someone has changed the administrator password.	If the correct password is not found, you must reset the password. Contact your supplier for a reset code. You must provide the serial number and IMEI number of the terminal. Then enter the web interface and reset the password as described in: <i>To reset the administrator password on page 76.</i>

Status signalling

The terminal has different means of status signalling, to help you find the cause of a problem:

- Indicators.
- Event messages.
- Event log.

Indicators, event messages and logs are described in the following sections.

Power indicator

The SAILOR Fleet One terminal has one LED indicator.



Functions of the Power indicator.

LED status	Meaning
Off	Unit is off
On, green	Unit is on, normal operation
Flash pattern, green	Starting up
Flash pattern, orange	Shutting down

Generate a diagnostic report

The diagnostic report contains relevant information for troubleshooting. When contacting your distributor for support, please enclose this file.

To generate a diagnostic report, access the web interface of the SAILOR Fleet One and do as follows:

1. From the left navigation pane, select **HELP DESK**.



2. Click **Generate report**.

In some browsers the file may open directly in your browser.

Note It normally takes about 1 minute, sometimes longer, to generate the report. The report may open in your browser while being generated. Wait until the report is finished before saving the file.

3. To save the file, select **File > Save as** in your browser.
4. Choose a location for the file and save it.

Event messages

Display of event messages

The terminal can detect events during POST (Power On Self Test) or CM (Continuous Monitoring). When the terminal detects an event that requires your action, it issues an event message.

You can see the active event messages in the web interface by clicking the warning symbol in the icon bar at the top in the web interface. You can also see the messages in the Thrane IP Handset.

All events are logged in the event log.

Event list or Event log

When an event is registered, the web interface shows an event icon in the icon bar  as long as the event is active.

The **Event list** only shows events that are currently active, whereas the **Event log** shows the history of events that have occurred.

- To see the **Event list** click the event icon  from the icon bar at the top of the web interface, or select **HELPDESK > Event list** from the left navigation pane.
- To see the **Event log**, select **HELPDESK > Event log** from the left navigation pane. The Event log shows the same information as the Event list, but also includes events that occurred in the past and are no longer active. Additionally, it lists events of informational character, describing normal phases of operation for the terminal.

List of events

The following list explains most of the events that may show in the web interface of the terminal. Note that the list is not complete.

Note Events with “Info” level are not included in this list. Only events that can appear in the Event list and cause a warning icon  in the web interface are included.

ID	Event Text	Explanation	Remedy
00100 to 00199	System data damaged	Important system data is damaged	Do not use the terminal. Contact your distributor.
00210 to 00219	SIM module error	The SIM interface on the terminal cannot be used.	Contact your distributor.
00240 to 00249	Temperature sensor error	The terminal is in danger of overheating.	Do not use the terminal. Contact your distributor.
00260 to 00269	System error	The terminal cannot communicate on the satellite network.	Contact your distributor.

ID	Event Text	Explanation	Remedy
00270 to 00279	Voice module error	Voice services cannot be accessed by the terminal	Contact your distributor.
00280 to 00289	Ethernet module error	The Ethernet interface on the terminal cannot be used.	Contact your distributor.
00300 to 00309	GPS module error	The GNSS module is out of function. The terminal cannot obtain a valid position.	Contact your distributor.
00340 to 00349	2-wire failure	The Phone interface of the terminal cannot be used.	Contact your distributor.
00350 to 00359	AD9864 calibration data error	Internal error in the receiving part of the terminal.	Contact your distributor if the problem persists.
00360 to 00369	No antenna found	The terminal cannot communicate with the antenna.	<ul style="list-style-type: none"> • Check the cable between terminal and antenna. • Reboot the terminal.
01010 to 01019	Temperature too low (critical)	Low ambient temperature is causing the performance of the terminal to be degraded or halted.	<p>Move the terminal to a warmer location.</p> <p>For information on ambient temperature limits, see the installation manual.</p>
01020 to 01029	Too low temperature warning	<p>Low ambient temperature is causing the performance of the terminal to be degraded or halted.</p> <p>The terminal will assume radio silence if the problem is in the ACM module of the antenna.</p>	<p>Move the terminal to a warmer location.</p> <p>For information on ambient temperature limits, see the installation manual.</p>
01110 to 01119	Temperature too high (critical)	<p>Terminal: Critically high temperature is causing the terminal to shut down.</p> <p>Antenna: Critically high temperature is causing the antenna to stop transmission.</p>	<p>If possible, move the failing unit to a cooler location.</p> <p>For information on ambient temperature limits, see the installation manual.</p> <p>Contact your distributor if the problem persists.</p>
01120 to 01129	Too high temperature warning	<p>High ambient temperature is causing the performance of the system to be degraded or halted.</p> <p>The bit rate is reduced.</p>	<p>Move the terminal to a cooler location.</p> <p>For information on ambient temperature limits, see the installation manual.</p>

ID	Event Text	Explanation	Remedy
01400 to 01409	Satellite signal lost	The SAILOR Fleet One no longer receives a signal from the satellite.	Make sure the SAILOR Fleet One has a clear view to the satellite.
01500 to 01509	SIM card missing	No SIM card is detected in the SIM slot.	Insert SIM card. If the SIM card is already inserted, try removing and reinserting it.
01600 to 01609	SOS calls only	The SIM card is not accepted by the network. Only emergency calls are allowed.	Enter the PIN and wait for network approval. If the problem persists, contact your Airtime Provider.
01700 to 01709	Registration for voice failed	The SAILOR Fleet One has not yet been allowed to register for voice services (Circuit-Switched).	Restart the terminal. If the problem persists, contact your Airtime Provider.
01800 to 01809	Registration for data failed	The SAILOR Fleet One has not yet been allowed to register for data services (Packet-Switched).	Restart the terminal. If the problem persists, contact your Airtime Provider.
02000 to 02009	Satellite signal weak	The signal from the satellite is weak.	Check the line of sight to the satellite. Check in the web interface under SETTINGS > Satellite selection that you have selected Auto , or a satellite covering your current position.
02100 to 02109	Ciphering Off	The network has turned ciphering off.	Do not transmit data that requires ciphering.
02200 to 02209	Ethernet data session failed	Ethernet data session could not be established.	See the call log for the cause of the error. Refer to <i>Call log</i> on page 59. If the problem persists, contact your distributor.
02900 to 02909	Network failed authentication	The SAILOR Fleet One does not accept the network as a valid BGAN network.	Restart the terminal. If the problem persists, contact your distributor.

ID	Event Text	Explanation	Remedy
03500 to 03509	2-wire calibration failure	2-wire calibration failed on the Phone interface, because of: <ol style="list-style-type: none"> 1. Common mode balance error. 2. The phone is off-hook. 3. Wires are shorted to each other or to ground. 	<ol style="list-style-type: none"> 1. Check the wires to your phone. 2. Put phone on hook. 3. Check the wires.
03600 to 03609	2-wire operational failure	The Phone interface fails to operate. Possible reasons: <ol style="list-style-type: none"> 1. Ground shorted. 2. Power overload. 3. Temperature overload. 	<ol style="list-style-type: none"> 1. Check the wires. 2. Wait until the event is cleared; then try again. 3. Wait until the event is cleared; then try again.
08002	One or more ports has PoE disabled due to power limitations	The power supply to the terminal has dropped critically. PoE is disabled to ensure enough power to the antenna.	Ensure a stable power supply to the terminal.
08008	Antenna exceeds voltage threshold	The antenna voltage is either too high or too low.	Check the cable to the antenna. Contact your distributor if the problem persists.
08009	Power Hold-up - the terminal can no longer power the antenna	The power supply to the terminal has dropped for too long. The antenna does not have enough power to function.	Ensure a stable power supply to the terminal.
0800B	PoE Overvoltage protection is activated	Overvoltage is detected in the terminal. The terminal will be shut down in 10 minutes.	Do not use the terminal. Contact your distributor.
0800D	Antenna Overvoltage protection is activated	Overvoltage is detected in the antenna. The terminal will be shut down in 10 minutes.	Do not use the terminal. Contact your distributor.

ID	Event Text	Explanation	Remedy
08010	Undervoltage has been detected	The input voltage has dropped below an acceptable level. The terminal will be shut down in 10 seconds if the situation persists.	Ensure a stable power supply to the terminal.
0801B	Lost connection to the GPS receiver	Communication with the GNSS receiver in the antenna is lost.	Restart the terminal. Contact your distributor if the warning persists.
0801D	Uploading firmware to antenna	New firmware is being uploaded to the antenna. The Event will be cleared when upload has finished.	Contact your distributor if the Event is not cleared within 5 minutes.
0802C	Firmware update still fails after several retries	The terminal was unable to upload new firmware to the antenna.	Contact your distributor.
0802D	Firmware update failed	The terminal was unable to upload new firmware to the antenna.	Reboot the terminal. Then update the software again. Contact your distributor if the problem persists.
0802E	Firmware is older than current antenna version	The firmware in the antenna is newer than expected by the terminal.	Update the terminal software.
0802F	Antenna main image could not be loaded	Antenna failed to start up normally.	Reboot the terminal. Contact your distributor if the problem persists.
08030	Antenna could not enter main application mode	Antenna failed to start up normally.	Reboot the terminal. Contact your distributor if the problem persists.
08031	Failed to enter normal operation	Antenna failed to start up normally.	Reboot the terminal. Contact your distributor if the problem persists.
08032	Firmware image version lower than active antenna version	The firmware in the antenna is newer than expected by the terminal.	Update the terminal software.

ID	Event Text	Explanation	Remedy
08033	Firmware image doesn't support antenna hardware	The antenna hardware version is not supported by the terminal.	Check that both the antenna and the terminal are of the type SAILOR Fleet One. Contact your distributor if the problem persists.
08034	Antenna failed to exit Flash Manager. Power cycle needed	New firmware was successfully uploaded to the antenna but the antenna failed to start normally with the new firmware.	Reboot the terminal. Contact your distributor if the problem persists.
08035	Unable to open port for HPA burst monitoring	There was an error communicating with the antenna.	Reboot the terminal. Contact your distributor if the problem persists.
08040	Excessive writes to the flash memory	Typically caused by wrong configuration of APN name or user name/password for a profile which is set to auto-activate.	Check that the APN name, user name and password are set up correctly for your profiles.
08045	Antenna - Startup temperature too low	The temperature in the antenna is too low for the system to start up	None. If the ambient temperature is outside the specified limits, the antenna may not be able to start up properly. Refer to the installation manual for temperature specifications.
08046	Timeout of startup sequence - No antenna or antenna temperature too low	The start-up sequence of the terminal has timed out because: <ul style="list-style-type: none"> • the antenna is not properly connected, or • the antenna temperature is too low to start up. 	Check that the antenna cable is properly connected at both ends.
08048	All PoE ports except port 1 are shut down due to high temperature	The temperature in the terminal is too high. PoE port 2 is shut down to reduce the temperature.	Move the terminal to a cooler location, or avoid using PoE on port 2.
08049	Data rate reduction due to high temperature	The bit rate of the data channel is reduced because the temperature is too high.	Move the terminal to a cooler location

ID	Event Text	Explanation	Remedy
0804B	Illegal combination of antenna and terminal	You are not using the right combination of antenna and terminal.	Only use the antenna(s) intended for use with your terminal.
0804C	The selected satellite is not visible at current GPS position	The terminal is set up to use a satellite that is not visible at the current position.	Enter the web interface and select SETTINGS > Satellite selection . Then select Auto to let the terminal automatically find the satellite with the best signal, or select a satellite visible from your current position.
0804D	Antenna firmware image is missing in terminal	The software is corrupt	Upload new software to the terminal. Refer to <i>Update software</i> on page 93.
08054	Transmission aborted due to extreme temperature	The system stops all transmission due to: <ul style="list-style-type: none"> • critically high temperature in the HPA or ACM module of the antenna, or • too low temperature in the ACM module. 	None. The antenna must operate within the allowed temperature range to work properly. For information on ambient temperature limits, see the installation manual.
08056	USIM rejected	The type of USIM card inserted in the terminal is not correct for your terminal.	Make sure you have the correct type of USIM card. E.g. an USIM card for a land-mobile system will not work for a maritime system and vice versa.
08060	NAT session table full	There are too many open connections through NAT - typically too many users generating too much web traffic.	Do not establish new connections until the load has been reduced.

Extended status

To see the Extended status page, select **HELPDESK > Extended status**.

To see updated information on the **Extended status page**, click **Refresh**.

The Extended Status page shows the following information:

- The antenna Product ID (must always be TT-3050C-581).
- The status of the connection to the air interface (IAI-2). This field should normally show “Registered”, unless the system is still in the startup process.
- Ongoing data sessions (IP address) and connection status, e.g. Active or Suspended.
- Ongoing calls and their connection status.

Antenna properties

Select **SETTINGS** from the left navigation pane. The **SETTINGS** page shows properties of the connected antenna.

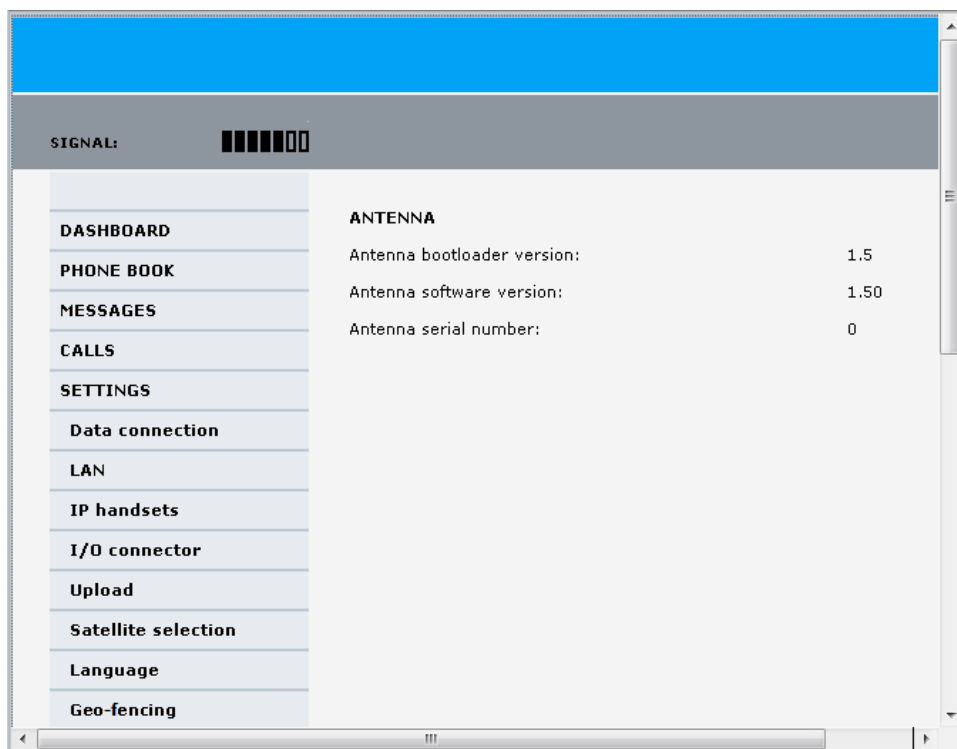

Note If the HPA module in the antenna has been exchanged, the Antenna serial number field shows “0”. You can still see the antenna serial number on the label on the underneath of the antenna.

Self test

The Self test performs system test on the SAILOR Fleet One system, similar to the tests that are performed during the Power On Self Test (POST).

Important | The terminal must reboot to perform the self test. All ongoing calls or data sessions will be terminated.

To activate a self test, do as follows:

1. Select **HELPDESK > Self test**.

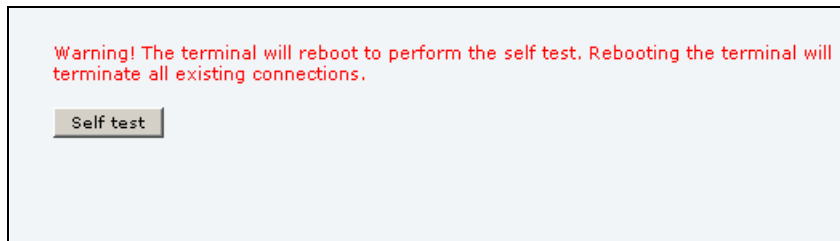

2. Click **Self test**.
3. Click **OK** in the Warning dialog

The terminal now reboots and performs a self test.

Reset button

To access the Reset button

The terminal has a Reset button placed next to the SIM slot behind the SIM cover. The functions of this button is described below.

To press the Reset button, use a pointed device.



Function of the Reset button

The Reset button on the terminal has the following functions:

Action	Function
With the terminal running, press the Reset button normally.	The terminal IP address and IP netmask are temporarily set to the default value (default IP address: 192.168.0.1). With this function, even if the IP address has been changed and you do not remember the new IP address, you can still access the web interface and see your current configuration. The default value is not saved in the configuration, but is only valid until next reboot.
With the terminal running, press and hold the Reset button for 30 seconds, until the Power indicator on the terminal is flashing orange.	The terminal restores factory settings and reboots the system.

Action	Function
While the terminal is booting, press and hold the Reset button.	<p>For service use only!</p> <p>The bootloader initiates software upload. This firmware upload procedure is only to be used if the other procedures fail due to missing or corrupted firmware.</p> <p>This setup uploads software to the terminal from a TFTP server via the LAN connection. The procedure is as follows:</p> <ol style="list-style-type: none">1. Activate or install a TFTP server on a PC.2. Locate the correct software image (xxx.dl) for the terminal and place it in the TFTP server directory.3. Rename the image to ttexp.dl.4. Reconfigure the PC LAN interface to use the static address 192.168.0.2/255.255.255.0.5. Power off the terminal.6. Connect the PC LAN Interface to the terminal.7. Press and hold down the Reset button.8. Keep the Reset button pressed while powering on the terminal, and through the next step.9. Monitor the TFTP server window. When the upload starts you can release the Reset button. <p>When the TFTP upload finishes the terminal boots up using the new image.</p>

List of reserved subnets

Some IP subnets are reserved for internal use in the terminal. If any of these addresses are assigned to external equipment connected to the terminal, the terminal and connected equipment will not be able to communicate.

The following local IP subnets are reserved for internal use in the terminal. The netmask for all of these subnets is **255.255.255.0**.

192.168.2.0	192.168.17.0
192.168.3.0	192.168.18.0
192.168.4.0	192.168.19.0
192.168.5.0	192.168.20.0
192.168.6.0	192.168.21.0
192.168.7.0	192.168.22.0
192.168.8.0	192.168.23.0
192.168.9.0	192.168.24.0
192.168.10.0	192.168.25.0
192.168.11.0	192.168.26.0
192.168.16.0	

Technical specifications

SAILOR Fleet One antenna

General specifications

Item	Specification
Frequencies	
Inmarsat I-4	
Transmit	1626.5 - 1660.5 MHz
Receive	1525.0 - 1559.0 MHz
Inmarsat Alphasat	Extended L-Band (XL) ^a
Transmit	1626.5-1660.5 MHz and 1668.0-1675.0 MHz
Receive	1518.0 - 1559.0 MHz
Channel spacing	1.25 kHz
Antenna element gain Rx	11.0 dB min.
G/T	≥ -15.5 dB/K
EIRP	Min. EIRP: 3.1 dBW Max. EIRP: 16.1 dBW
Return loss	< -15 dB (reflection loss < 0.15 dB)
Cable losses	RF attenuation: max. 20 dB DC resistance (loop): max. 1 Ohm Max. cable length between terminal and antenna: <ul style="list-style-type: none"> • RG223-D: 25 meter • RG214/U: 50 meter • S 07272B-05: 95 meter
Antenna input voltage	22.7 V
Antenna power, operational	Maximum 39 W
Total antenna weight	3.94 kg (8.7 lbs)
Antenna dimensions	291.9 mm x Ø275.6 mm

a. The extended frequency range (Extended L-Band or XL) is only available within Alphasat coverage. For coverage area, see *Satellite coverage* on page 5.

Environmental specifications

Item	Specification
Water and dust	IPX6 spray proof in all directions, no dust test.
Ambient Temperature	Operational: -25° to +55 °C Storage: -40° to +85 °C
Operating humidity	100%, condensing
Ice, survival	Up to 25 mm of ice
Wind load, max.	Normal operation with relative average wind velocity up to 200 km/h (56 m/s, 108 knots)
Vibration, operational	Random spectrum 1.05 g rms x 3 axes: 5 to 20 Hz: 0.02 g ² /Hz 20 to 150 Hz: -3 dB/octave Sine: 2 to 13.2 Hz: ± 1 mm 13.2 to 100 Hz: 7 m/s ² 2 h dwell at resonances
Vibration, non-operational	Random spectrum 1.7 g rms 2 h x 3 axes 6 h total): 5 to 20 Hz: 0.05 g ² /Hz 20 to 150 Hz: -3 dB/octave
Vibration, life test	At least 1.7 g rms for 2 hours per axis. Spectrum: 5 to 20 Hz: 0.05 g ² /Hz, 20 to 150 Hz: -3 dB/octave
Shock	Half sine, 20 g/11 ms
Solar radiation	1120 W/m ² according to MIL-STD-810F 505.4
Air Pressure, operational	1500 m AMSL
Air Pressure, transport	4572 m AMSL MIL-SPEC 810E 500.4

Item	Specification
Ship motions (MAX)	Roll: 30°, period 4 sec., 0.7 g tangential Pitch: 15°, period 3 sec., 0.6 g tangential Yaw: 10°, period 5 sec., 0.3 g tangential Surge: 0.5 g Sway: 0.5 g Heave: 0.7 g Turning rate: 36°/s; 12°/s ² Headway: 22 m/s (42 knots)

Minimum distance to transmitters

The table below shows the minimum recommended distance to transmitters in the frequency range below 1000 MHz.

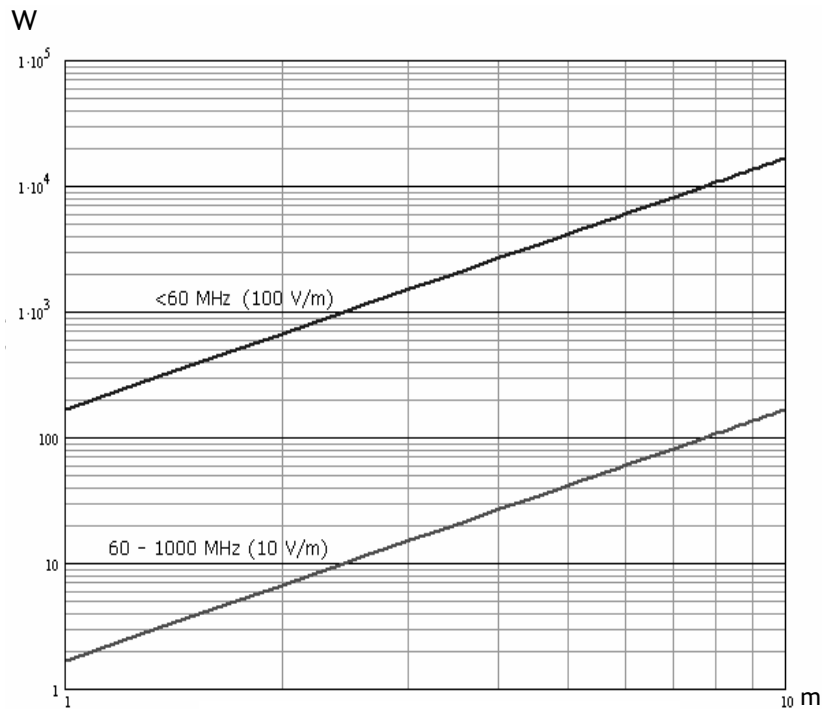

Recommended distance to SAILOR Fleet One antenna.

Outline, SAILOR Fleet One antenna

Dimensions are in mm.

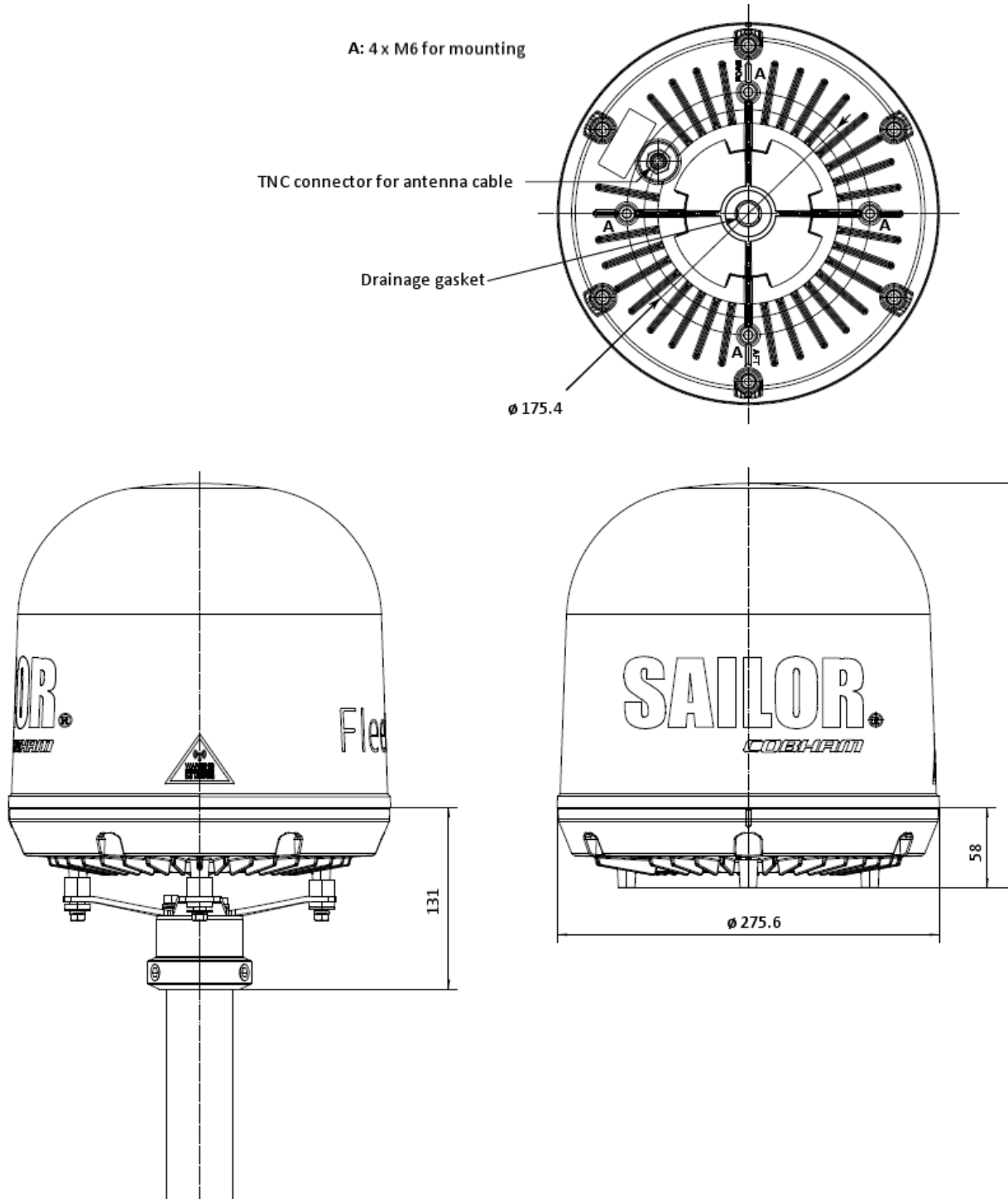

SAILOR Fleet One terminal

General specifications

Item	Specification
Weight	2.2 kg (4.9 lbs)
Dimensions	231 mm x 278 mm x 41 mm (9.1" x 10.9" x 1.6")
Global services	
Voice	4 kbps AMBE+2
Data	Up to 100 kbps
SMS	
2-wire telephone interface	One connector: RJ-11 female. 600 Ohm ITU-T Rec. G.473, standard DTMF telephone. Supported cable length: up to 100 meters.
LAN interface	Two connectors: RJ-45 female 10/100 Mbps. Supported cable length: up to 100 m PoE (max. 15.4 W) on each port, Total PoE power: 32 W. Conforms with IEEE 802.3 af
I/O interface	One connector with 5 configurable inputs/outputs.
Output:	Open collector, Short circuit protected at 1.5 A and reverse polarization protected.
Open switch hold-off voltage	max. 32 V
Open circuit resistance	min. 130 kOhm
Closed switch voltage	max. 1 V DC at 50 mA
Input:	
Input resistance	min. 130 kOhm
Voltage	Max. 32 V
Voltage High	Min. 2.2 V
Voltage Low	Max. 1.2 V

Item	Specification
Antenna interface	One connector, TNC-female Inmarsat I-4 power: 1525 to 1559 MHz: -94 dBm to -64 dBm 1626.5 to 1660.5 MHz: -9 dBm to +11 dBm Inmarsat Alphasat power: ^a 1518 to 1559 MHz: -94 dBm to -64 dBm 1626.5 to 1660.5 MHz and 1668.0 - 1675.0 MHz: -9 dBm to +11 dBm Power supply: 18-29 V DC
Power input	Connector: Mixed D-Sub 7W2 Nominal 12/24 VDC (10.5 - 32 V DC; 11.5 A - 4 A) Max. source impedance: 85 mOhm at 12 V, 500 mOhm at 24 V Maximum 20 A at 24 V, 5 ms (start up) Maximum power consumption: 120 W
Power consumption	Measured with wave simulator
Idle, no waves	No peripherals connected: 15,67 W
Idle, w. waves	IP handset, phone and PC connected: 16,82 W Phone connected: 18,75 W
FTP transfer, w. waves	IP handset, phone and PC connected: 20,2 W Download: 21,4 W Upload: 31,09 W
Standby current	Ignition function, off: max. 15 mA Remote on/off in DC connector, off: max. 2 mA
Ambient temperature	Operational: -25° to +55 °C Storage: -40° to +80 °C
Relative humidity	95% non-condensing at +40 °C
Equipment category	Protected from the weather - IEC-60945

a. The extended frequency range (Extended L-Band or XL) is only available within Alphasat coverage. For coverage area, see *Satellite coverage* on page 5.

Outline, SAILOR Fleet One terminal

Connector panel, top view and end view. Dimensions are in mm.

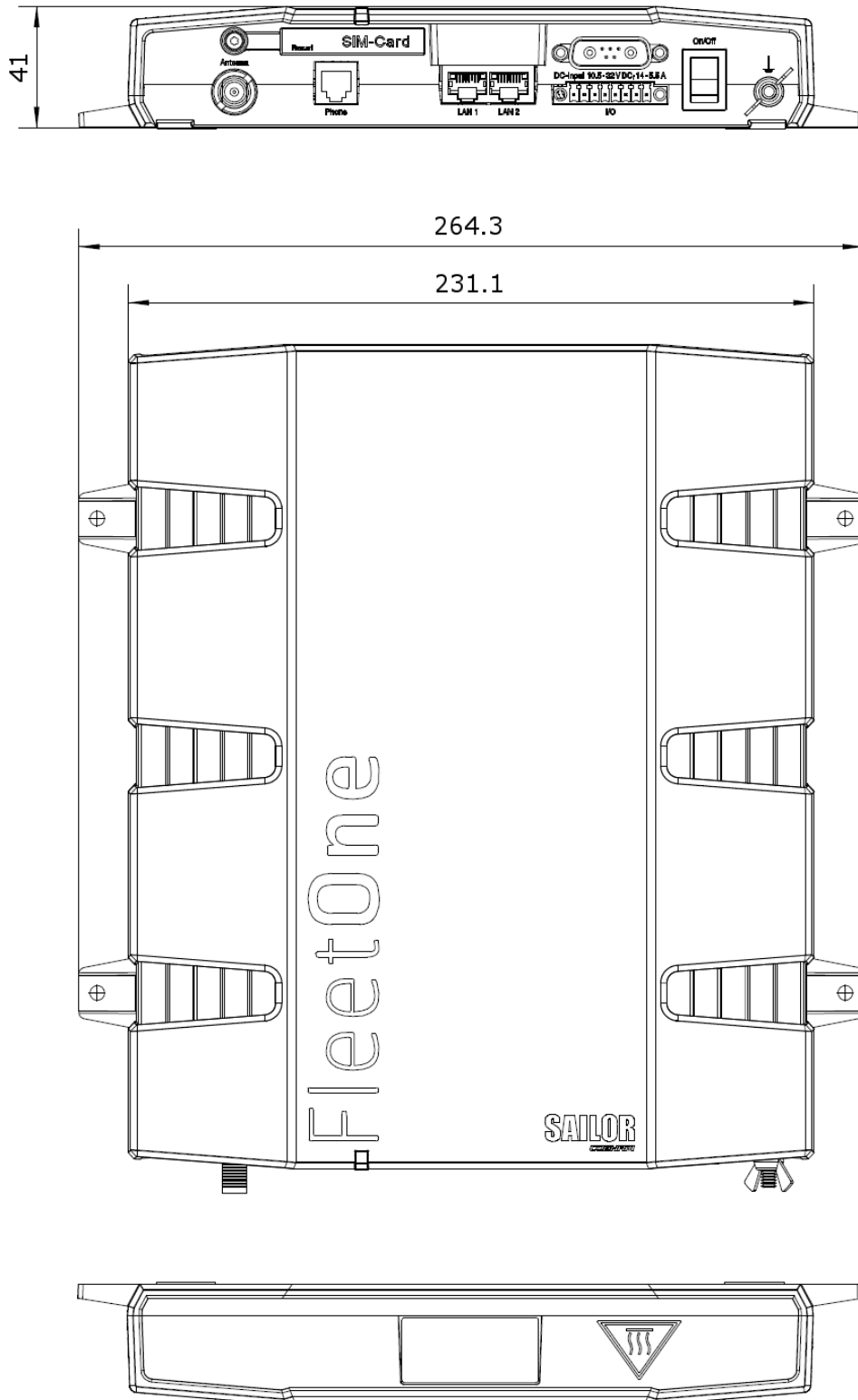

Side view and bottom view. Dimensions are in mm.

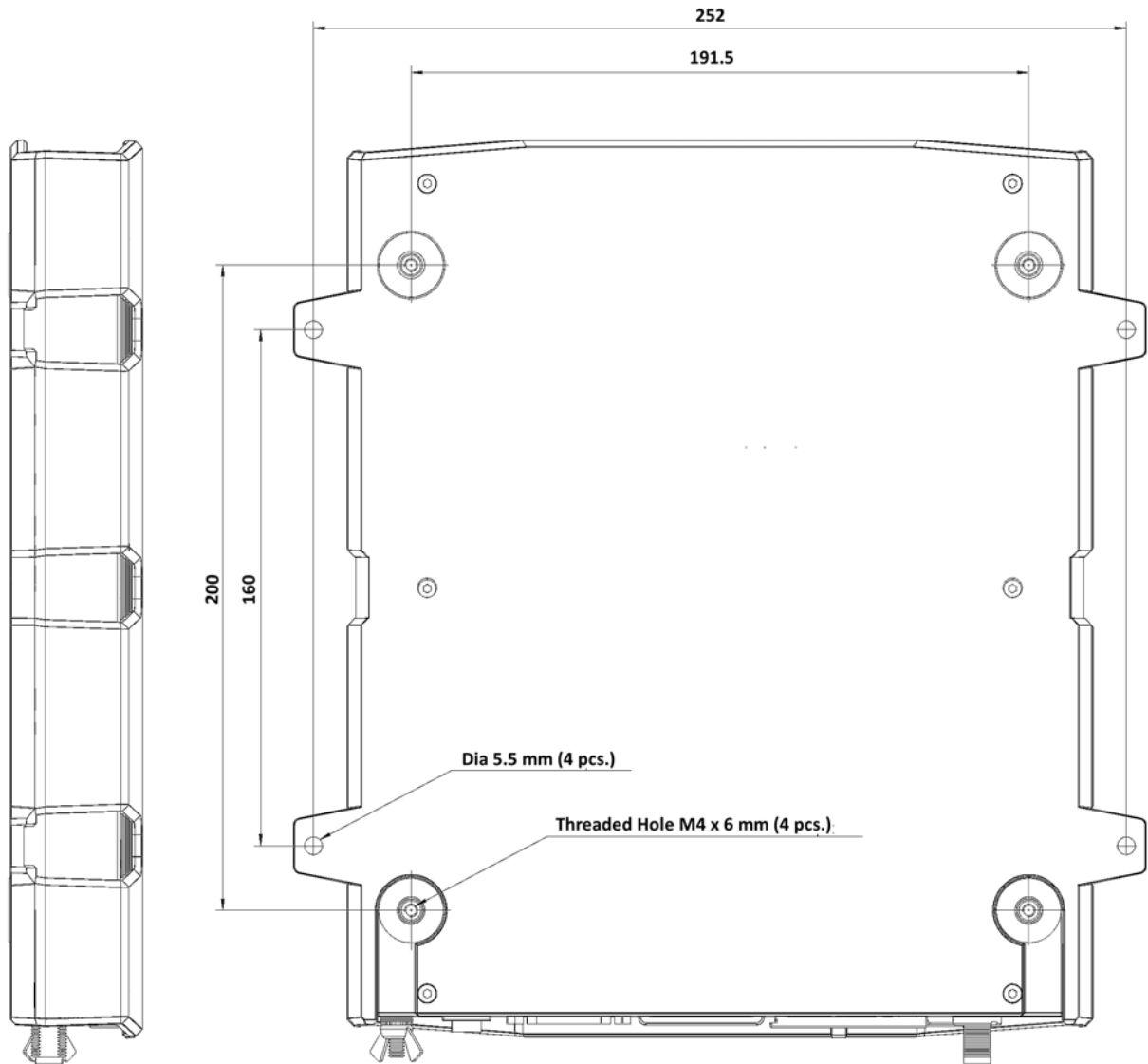

Weight: 2.2 kg.

A

- ATC** Auxiliary Terrestrial Component. Hybrid satellite terrestrial systems that use terrestrial repeaters to combine the wide area coverage capabilities of geostationary or low earth orbit satellites with urban coverage and in building penetration provided from terrestrial networks.
- AWG** American Wire Gauge. A means of specifying wire diameters.

B

- BeiDou** Chinese satellite navigation system
- BGAN** Broadband Global Area Network. A satellite network based on geostationary satellites, delivering broadband data and telephony to virtually any part of the earth, with full UMTS (3G) compatibility. BGAN enables users to access e-mail, corporate networks and the Internet, transfer files and make telephone calls.

C

- CE** Conformité Européenne. This term signifies that a CE certified product conforms to European health, environmental, and safety regulations. In short, it makes the product legal to be sold in the European Union.
- CM** Continuous Monitoring

D

- DHCP** Dynamic Host Configuration Protocol. A protocol for assigning dynamic IP addresses to devices on a network. With dynamic addressing, a device can have a different IP address every time it connects to the network.
- DTMF** Dual Tone Multi Frequency. The keypad signalling technology that generates two distinct tones when each key is pressed. This system allows navigation of voice menus and other advanced calling services. All wireless phones use DTMF dialing.

E

- EIRP** Effective Isotropically-Radiated Power. The amount of power that would have to be emitted by an isotropic antenna (that evenly distributes power in all directions) to

produce the peak power density observed in the direction of maximum antenna gain.

G

GLONASS GLObal'naya NAVigatsionnaya Sputnikovaya Sistema. Global Navigation Satellite System in English.

GPS Global Positioning System. A system of satellites, computers, and receivers that is able to determine the latitude and longitude of a receiver on Earth by calculating the time difference for signals from different satellites to reach the receiver.

I

I/O Input/Output

IAI-2 Inmarsat Air Interface-2. The air interface used for BGAN. IAI-2 is an evolution of MPDS with new bearer types, which give a wide range of data rates from 16 kbps up to 492 kbps. By utilizing different modulation schemes, variable coding rate and power adjustment, it is possible to change the bearer type to give optimum throughput with efficient use of the satellite resources.

IMEI International Mobile Equipment Identity. A unique number identifying your terminal.

IMSO International Maritime Satellite Organisation. An intergovernmental body established to ensure that Inmarsat continues to meet its public service obligations, including obligations relating to the GMDSS.

L

LAN Local Area Network. A computer network covering a small physical area, like a home, office, school or airport. The defining characteristics of LANs, in contrast to wide-area networks (WANs), include their usually higher data-transfer rates, smaller geographic area, and lack of a need for leased telecommunication lines.

LED Light Emitting Diode

N

NAT Network Address Translation. An Internet standard that enables a local-area network to use one set of IP addresses for internal traffic and a second set of addresses for external traffic. A NAT module makes all necessary address translations.

P

PoE Power over Ethernet. A standard for combining power supply with transmission of data over the Ethernet. The source unit "injects" power into the Ethernet cable and the power is "picked up" at the connected device.

POST Power On Self Test. A test sequence that runs every time the system is powered up or reset.

R

RF Radio Frequency. Electromagnetic wave frequencies between about 3 kilohertz and about 300 gigahertz including the frequencies used for communications signals (radio, television, cell-phone and satellite transmissions) or radar signals.

S

SAS Satellite Access Station. The gateway between the satellites and the worldwide networks such as Internet, telephone network, cellular network etc.

SIM Subscriber Identity Module. The SIM provides secure storing of the key identifying a mobile phone service subscriber but also subscription information, preferences and storage of text messages.

SMS Short Messaging Service

T

TNC Threaded Neill-Concelman. A type of RF connector used for terminating coaxial cables. The TNC connector is a threaded version of the BNC connector. The connector has a 50 Ohm impedance and operates best in the 0-11 GHz frequency spectrum.

V

VPN Virtual Private Network. A network that is constructed by using public wires to connect nodes. You can create networks using the Internet for transporting data, using security mechanisms so that only authorized users can access the network.

W

WLAN Wireless Local Area Network

A

- access to settings
 - limit in web interface, 83
- administrator logon
 - web interface, 75
- administrator password
 - change, 77
 - reset, 76
- alarm messages, 101
 - list of, 101
- allowed numbers
 - restricted dialing, 84
- antenna
 - cables, 13
 - connector, 22
 - drainage, 14
 - environmental specifications, 114
 - grounding, 13
 - installation location, 7
 - installing, 13
 - interference, 8
 - mast design, 11
 - obstructions, 7
 - outline drawing, 116
 - radiation, 8
 - specifications, 113
 - viewing type, 108
- antenna properties, 108
- antenna RF noise filter, 90
- ATC resilience, 10, 90

C

- cable support, 19
- cables
 - antenna, 13
 - power, 34
- call charges, 79
- call limiting, 84
- call log, 59
 - clear, 80

calls

- IP handsets, enable or disable, 71
- make or receive, 46
- outgoing, received and missed, 59
- see in Dashboard, 56
- short dial, 58
- using WLAN access point, 40
- charge for call, 79
- clear call log, 80
- computer
 - connect, 42
 - types of connection, 50
- condensation in antenna, 14
- configuration
 - load from file, 78
 - save to file, 78
- connectors, 21
 - antenna, 22
 - DC input, 22
 - I/O interface, 28
 - LAN, 26
 - phone, 25

D

- dashboard
 - description, 54
- data connection
 - control switch, 32
 - overview, 49
 - see in web interface, 56
 - set up, 67
 - start, 44
- data connection status kit, 32
- data indicator lamp
 - connect, 33
- data limits, setting, 80
- delivery
 - items included, 6
- diagnostic report
 - generate, 100
- dialing restrictions, 84
- dialling prefixes, 48
- distance
 - antenna to GPS receiver, 10
 - antenna to radar, 8
 - between Inmarsat antennas, 10

distance to other transmitters, 115
drainage of antenna, 14
drawing
 antenna, 116
 terminal, 119

E

event messages, 101
events
 list of, 101
extended status, 108
external data connections
 set up, 86

F

filter for ATC, 90

G

GPS receiver
 distance from antenna, 10
grounding
 access, 16
 antenna, 13
 terminal, 17

H

humidity in antenna, 14

I

I/O connector, 28
 pin functions, 29
I/O interface
 set up, 72
ignition
 connecting, 24
indicator on terminal, 99
installation
 antenna, 13
 terminal, 17
interfaces
 set up, 68
interference, 8

Internet
 connect to, 44
IP addresses
 reserved, 112
IP handsets
 connect, 41
 connect to LAN interface, 27
 set up, 69
items included in delivery, 6

L

lamp for data indication, 33
LAN
 connector, 26
 set up, 68
LED indicator on terminal, 99
limit calls, 84
limit user access, 83
limitations in services, 4
load configuration from file, 78
local numbers, 48
log handling, 80
log on administrator, 75

M

mast for antenna, 11
maximum for data, 80
measuring source impedance, 34
messages of events, 101

O

obstructions
 distance and size, 7
outline drawing
 antenna, 116
 terminal, 119

P

part numbers, 95
password
 change, 77
 reset, 76
permissions
 setting for users, 83

phone
 connect, 42
 connector, 25
 types of connection, 45
phone book
 in web interface, 57
 limited numbers, 84
phone number
 of SAILOR Fleet One, 58
PIN
 change, 82
 enable or disable, 81
 enter in web interface, 63
 enter with a phone, 64
 enter with IP Handset, 64
pin functions
 I/O connector, 29
placing the antenna, 7
placing the terminal, 16
pole mount, 11
power
 cable extension, 35
 connector, 22
 indicator, 99
 switch on, 38
Power over Ethernet (PoE), 26
prefixes for dialling, 48
properties
 antenna, 108
 SAILOR Fleet One, 54

R

radar
 distance from antenna, 8
radiation level, 8
register with satellite network, 39
remote on/off, connecting, 24
reserved IP addresses, 112
reset button, 110
restricted dialing, 84
rights for users
 in web interface, 83
router function in terminal, 4

S

SAILOR Fleet One
 antenna specifications, 113
 drawing, antenna, 116
 drawing, terminal, 119
 phone number, 58
 terminal specifications, 117
satellite
 select, 73
satellite network
 connect to, 39
save configuration to file, 78
self test, 109
services
 limitations, 4
settings
 limit access, 83
short dial, 58
signalling status, 99
SIM card
 insert, 37
SIM PIN
 change, 82
 configure, 81
 enable or disable, 81
 enter, 63
SIP setup, 40
smartphone
 connect via WLAN access point, 39
SMS messages in web interface, 60
software
 download from Internet, 94
 update, 93
source impedance
 measuring, 34
special-purpose phone numbers, 48
specifications, 113
 antenna, 113
 antenna, environmental, 114
 terminal, 117
status
 extended, 108
 see in web interface, 54
 signalling, 99
subnets
 reserved (IP), 112
support, 92
switch for data connection, 32

T

- technical specifications, 113
- temperature, 16
- terminal
 - cable support, 19
 - grounding, 17
 - installation location, 16
 - installing, 17
 - outline drawing, 119
 - specifications, 117
- test
 - automatic, 109
- total counters, 56
 - clear, 80
- tracking setup, 88
- transmitters
 - minimum distance to other, 115
- troubleshooting guide, 96
- typography used in this manual, v

U

- unpacking, 6
- update software, 93
- user permissions
 - setting up in web interface, 83

W

- web interface
 - access, 51
 - administrator logon, 75
 - antenna properties, 108
 - call charges, 79
 - call log, 59
 - dashboard, 54
 - data connection, 67
 - description, 51
 - enter PIN, 63
 - event messages, 101
 - extended status, 108
 - external data connections, 86
 - I/O interface setup, 72
 - IP handset setup, 69
 - LAN setup, 68
 - load configuration from file, 78
 - log handling, 80
 - phone book, 57
 - save configuration to file, 78
 - select preferred satellite, 73
 - set up interfaces, 68
 - SMS messages, 60
 - tracking setup, 88
- WLAN access point
 - connect to LAN interface, 27
 - use for calls, 40

